

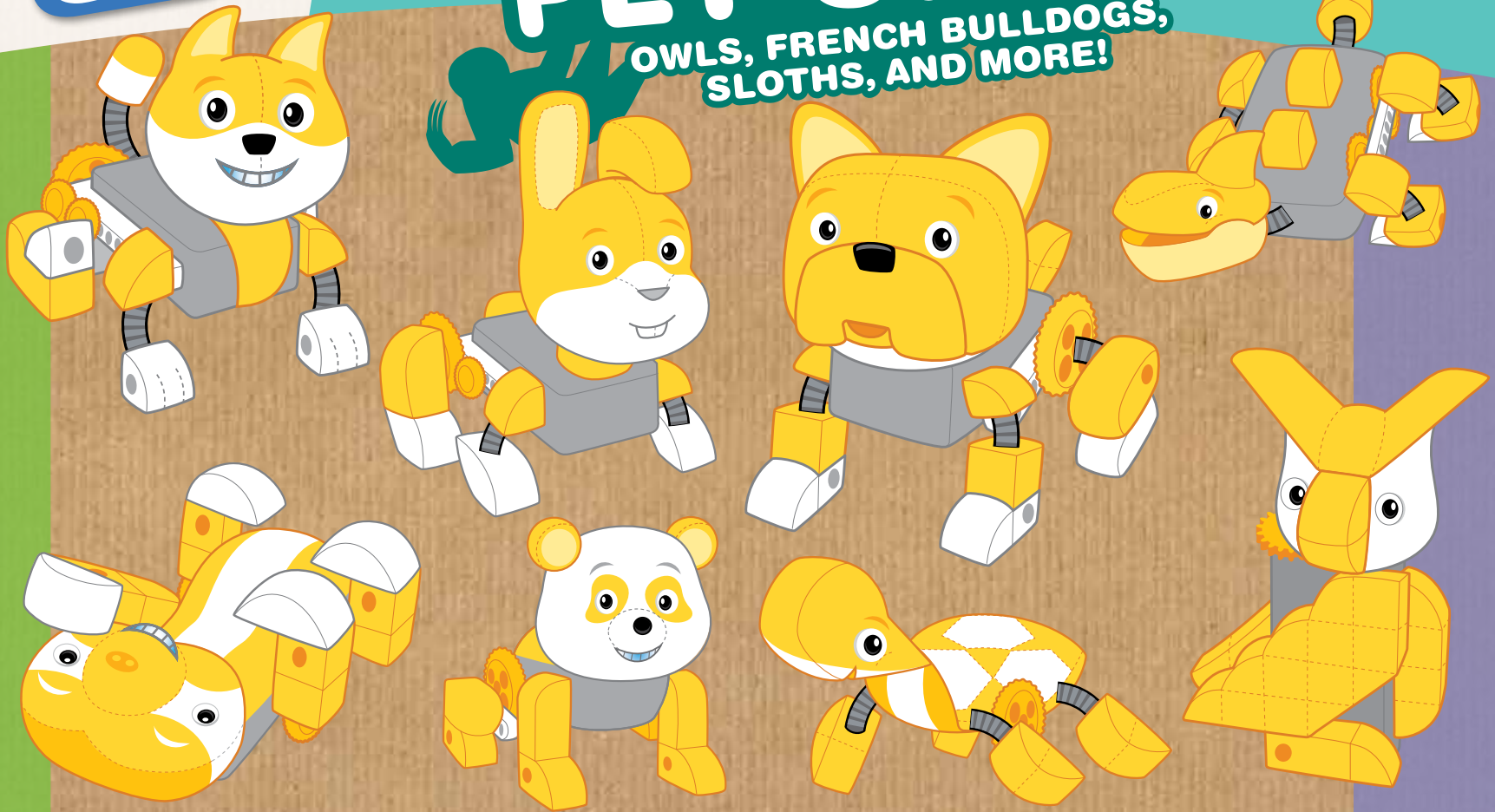

ROBOT PET SHOP

OWLS, FRENCH BULLDOGS,
SLOTHS, AND MORE!



THAMES & KOSMOS

Story and Instructions

>>> IMPORTANT INFORMATION

Dear Adult Helpers,

Engineering is an extremely exciting and vast field. This kit, along with its illustrated storybook and instruction manual, provides an engaging way to teach simple engineering concepts to preschool- and kindergarten-age kids.

Read the story with your child and build simple models of the fantastic robotic pets that the characters encounter in the pet shop. As you follow the story, your child can build models of the eight robots in the story with your help. The primary functional components of the robot models are motorized gears that make the robots move. Your child will be introduced to simple mechanical assemblies and motorized gear trains while building the models.

The models are assembled step by step using a construction system. It will require a little practice and patience at first. Please assist your children when they need your help, but also let them try to build the models by themselves. Your children will be happy to have your help with the models or assembly steps that pose particular difficulties.

We wish you and your child lots of fun building, discovering, and learning!

Safety Information

- >>> Warning! Not suitable for children under 3 years. Choking hazard — small parts may be swallowed or inhaled.
- >>> Keep the packaging and instructions as they contain important information.
- >>> Store the experiment material and assembled models out of the reach of small children.



WARNING:
CHOKING HAZARD — Small parts.
Not for children under 3 yrs.

Notes on Environmental Protection / Notes on Disposal of Electrical and Electronic Components:

The electronic components of this product are recyclable. For the sake of the environment, do not throw them into the household trash at the end of their lifespan. They must be delivered to a collection location for electronic waste, as indicated by the following symbol:



Please contact your local authorities for the appropriate disposal location.

Safety for Experiments with Batteries

- >>> To operate the models, you will need two AA batteries (1.5-volt, type LR6), which could not be included in the kit due to their limited shelf life.
- >>> Different types of batteries or new

and used batteries are not to be mixed.

- >>> Do not mix old and new batteries.
- >>> Do not mix alkaline, standard (carbon-zinc), or rechargeable (nickel-cadmium) batteries.
- >>> Batteries are to be inserted with the correct polarity. Press them gently into the battery compartments. See instructions above.
- >>> Always close battery compartments with the lid.
- >>> Non-rechargeable batteries are not to be recharged. They could explode!
- >>> Rechargeable batteries are only to be charged under adult supervision.
- >>> Rechargeable batteries are to be removed from the toy before being charged.
- >>> Exhausted batteries are to be removed from the toy.
- >>> The supply terminals are not to be short-circuited.
- >>> Avoid a short circuit of the batteries. A

short circuit can cause the wires to overheat and the batteries to explode.

- >>> Dispose of used batteries in accordance with environmental provisions, not in the household trash.
- >>> Be sure not to bring batteries into contact with coins, keys, or other metal objects.
- >>> Avoid deforming the batteries. As all of the experiments use batteries, have an adult check the experiments or models before use to make sure they are assembled properly. Always operate the motorized models under adult supervision. After you are done experimenting, remove the batteries from the battery compartments.
- >>> Note the safety information accompanying the individual experiments or models!
- >>> The toy is not to be connected to more than the recommended number of power supplies.

Batteries

How to insert and remove the batteries

Open the battery compartment by sliding the lid open. Insert two AA batteries. Make sure you fit the positive and negative ends into the compartment in the direction indicated (with the correct polarity). Then close the compartment. When it is time to replace the batteries, remove the old batteries and insert the new ones with the correct polarity.

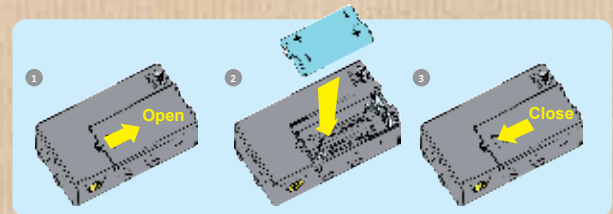

ROBOT PET SHOP

OWLS, FRENCH BULLDOGS,
SLOTHS, AND MORE!

Story by
Dan Freitas and Ted McGuire

Illustrations by
James Harmon



>>> KIT CONTENTS

GOOD TO KNOW!

If you are missing any parts, please contact Thames & Kosmos customer service.

What's inside your kit:

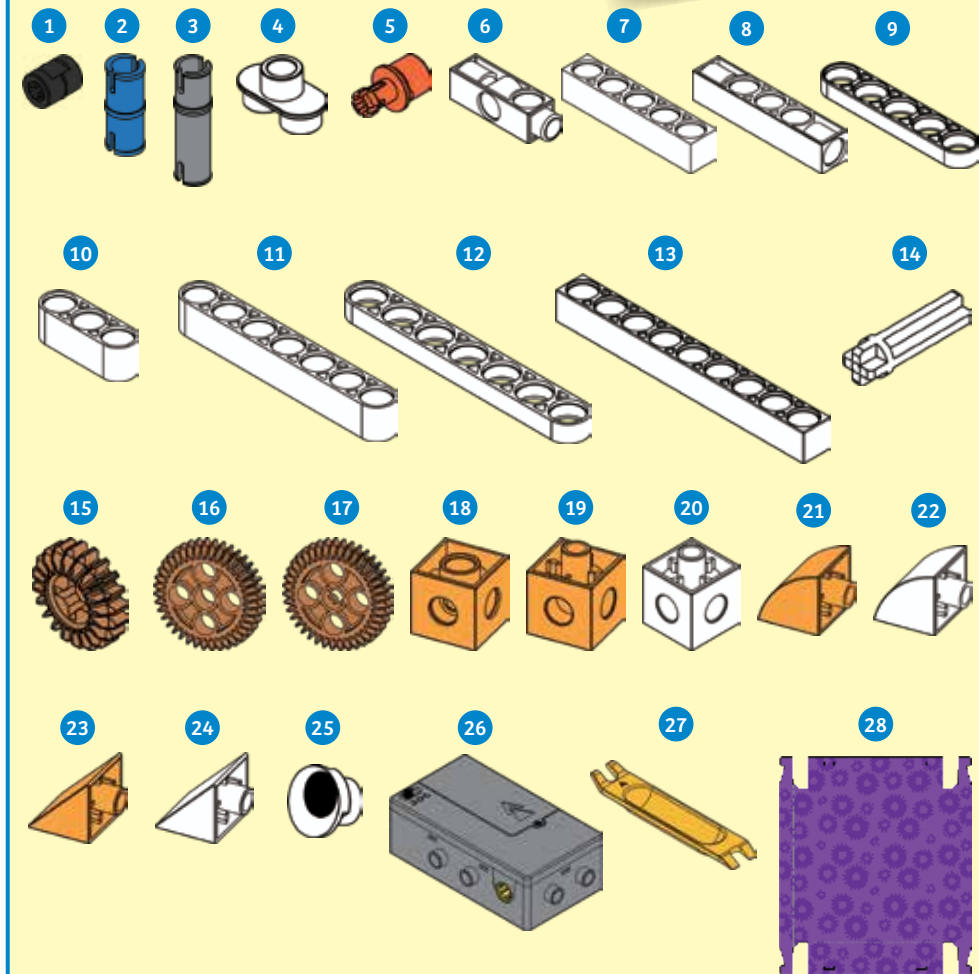

Checklist: Find – Inspect – Check off

✓	No.	Description	Qty.	Item No.
<input type="checkbox"/>	1	Short anchor pin, black	10	7344-W10-C2D
<input type="checkbox"/>	2	Joint pin, blue	6	7413-W10-T1B
<input type="checkbox"/>	3	Long joint pin, gray	4	7413-W10-U1S
<input type="checkbox"/>	4	Two-to-one converter	1	7061-W10-G1W
<input type="checkbox"/>	5	Shaft plug	2	7026-W10-H10I
<input type="checkbox"/>	6	3-hole dual rod	1	7413-W10-Y1W
<input type="checkbox"/>	7	5-hole rod	2	7413-W10-K2W
<input type="checkbox"/>	8	5-hole cross rod	2	7413-W10-R1W
<input type="checkbox"/>	9	5-hole flat rounded rod	1	7443-W10-C1W
<input type="checkbox"/>	10	3-hole rounded rod	2	7404-W10-C1W
<input type="checkbox"/>	11	7-hole rounded rod	2	7404-W10-C2W
<input type="checkbox"/>	12	7-hole flat rounded rod	2	7404-W10-C3W
<input type="checkbox"/>	13	9-hole rod	2	7407-W10-C1W
<input type="checkbox"/>	14	Motor shaft	2	7026-W10-L1W
<input type="checkbox"/>	15	Small gear	2	7026-W10-D2T
<input type="checkbox"/>	16	Medium gear, round hole	2	7408-W10-D1T
<input type="checkbox"/>	17	Medium gear, axle hole	2	7408-W10-D2T
<input type="checkbox"/>	18	6-hole cube block	4	880-W10-N1O3
<input type="checkbox"/>	19	Cube block, orange	15	880-W10-A1O3
<input type="checkbox"/>	20	Cube block, white	4	880-W10-A1W
<input type="checkbox"/>	21	Convex block, orange	12	880-W10-R1O3
<input type="checkbox"/>	22	Convex block, white	7	880-W10-R1W
<input type="checkbox"/>	23	Triangle block, orange	12	880-W10-S1O3
<input type="checkbox"/>	24	Triangle block, white	4	880-W10-S1W
<input type="checkbox"/>	25	Eye button pin	2	7128-W22-2
<input type="checkbox"/>	26	Motor and battery box	1	7450-W85-A
<input type="checkbox"/>	27	Part separator tool	1	7061-W10-B1Y
<input type="checkbox"/>	28	Pet bed die-cut cardboard	1	K16#7450-US

NOTE!

Please note the differences between the two types of orange gear wheels and the two types of orange cube blocks. Good engineers always pay close attention to the details!

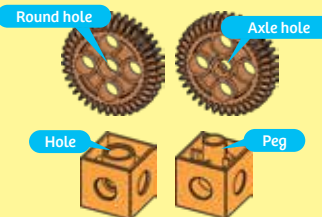



Meet the Omega Family!

Ty and Karlie Omega are siblings. They live in a small city called Makersville. Ty and Karlie's dad is a writer. He writes science fiction stories. Their mom is a mechanical engineer. She designs big machines used in factories.

They live in an awesome warehouse filled with tools, equipment, and building materials. There are always a number of projects going on in the warehouse.

Ty loves figuring out how things work. Karlie loves building things.

When Ty and Karlie were little, Ms. O designed Huxley, a robot that can build just about anything. For one of his first projects, Huxley converted Karlie's teddy bear, Remus, into a walking, talking science bear. Now Huxley and Remus are like members of the Omega family.

Karlie and Ty's Robot Pet Shop Adventure Began Here . . .

Karlie and Ty were at their home in Makersville, tending to their vegetable garden, when a rather strange-looking rabbit hopped into their yard. The rabbit headed directly to the bed of carrots that Karlie and Ty were planting.

"What a curious-looking bunny!" Ty exclaimed.

"I think it's actually a robot that just looks like a bunny," said Karlie.

The robot hopped right up next to them. Upon closer inspection, they found a small inscription above its tail, which read: "Designed in Makersville by Roy Rossum's Robot Pet Shop."

"Let's bring it back to this shop," suggested Karlie.

"Maybe we can get a tour!" Ty beamed with eyes wide. "Let's ask mom and dad if we can go."



RALEIGH THE RABBIT

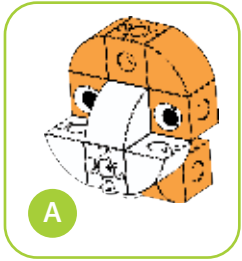
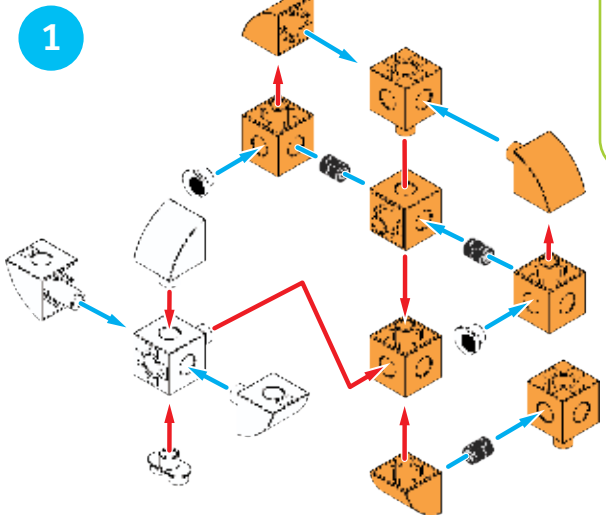

The green circles denote subassemblies used later.
Save the subassembly until it is called for again in the instructions.

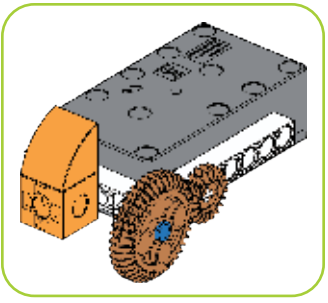
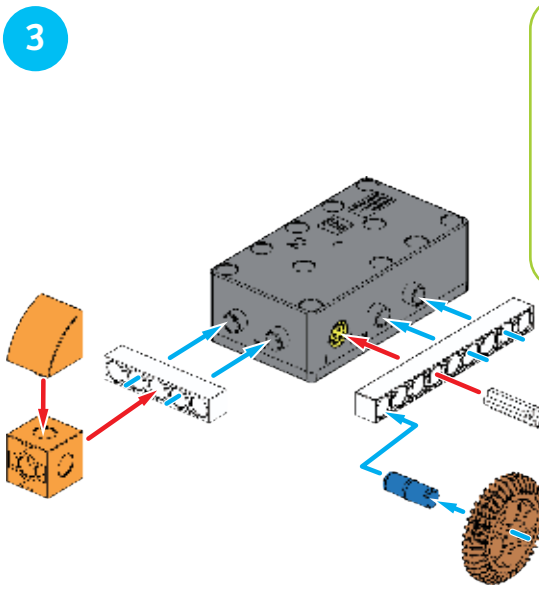
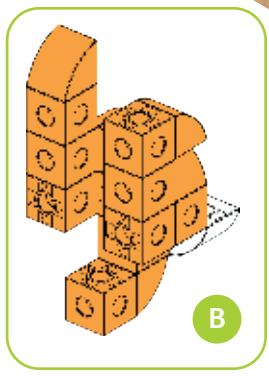
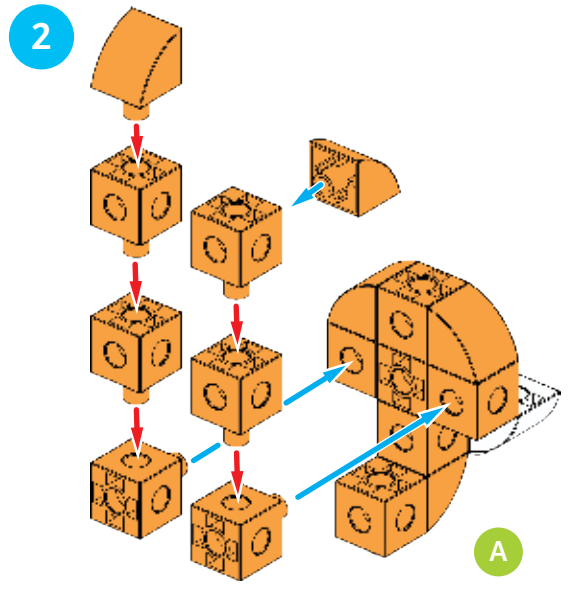

Round hole gear

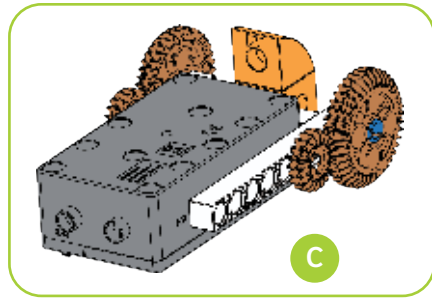
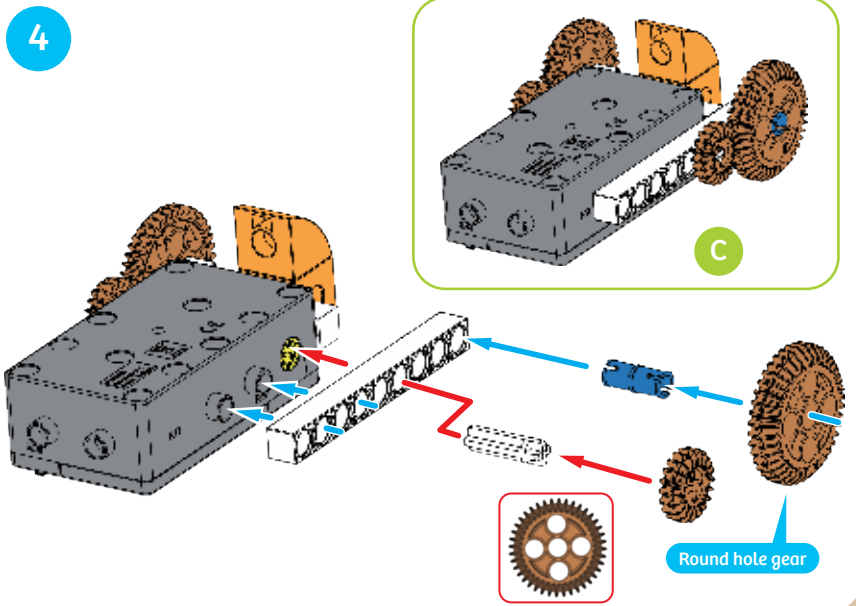

Round hole gear



5

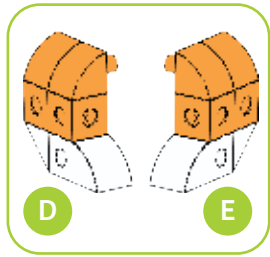
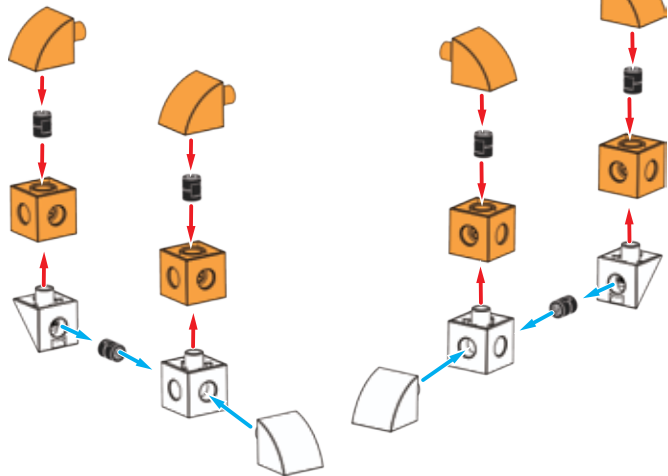

6

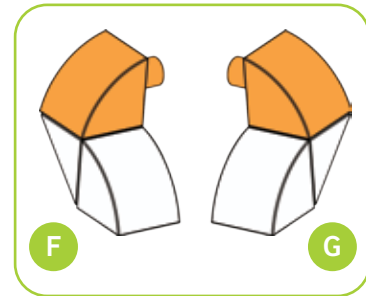
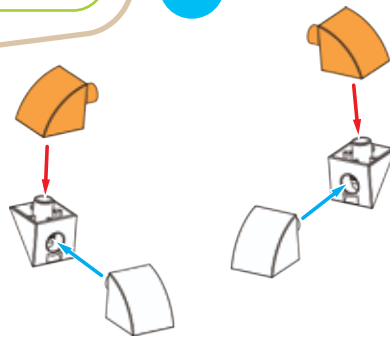

7

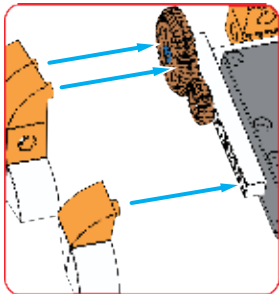

Right side

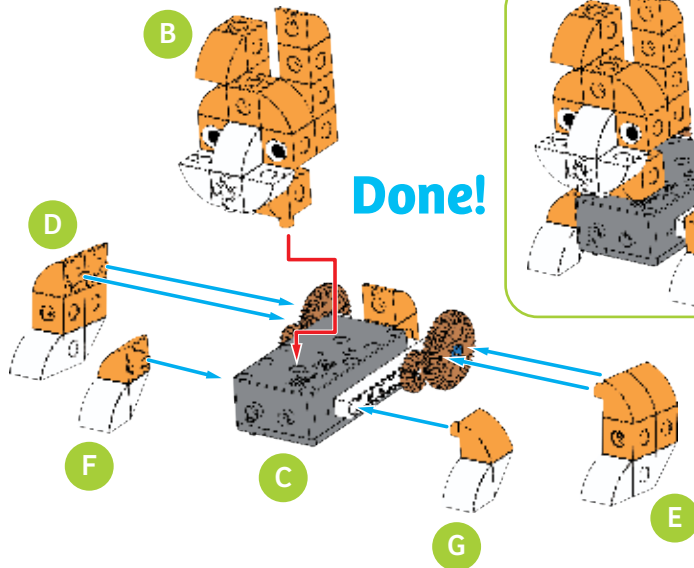

Done!

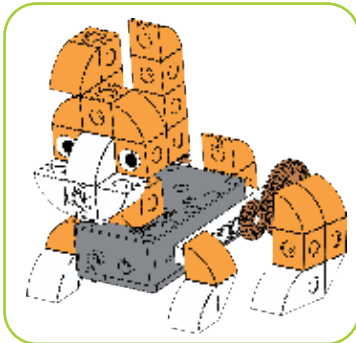

The model of Raleigh the Rabbit moves forward due to its motorized hind legs. The motor inside the motor box turns the small gears, which mesh with the medium gears, causing both medium gears to turn. The rabbit's hind legs are off-center on the gears, so they function like cams, which are mechanisms that turn rotating motion into up-and-down or back-and-forth motion. In this model, the cams turn the rotating motion of the gears into the up-and-down hopping motion of the rabbit.

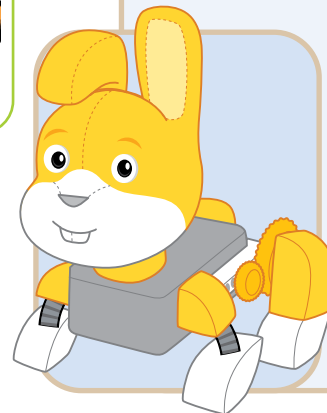

After getting permission from their parents, Ty and Karlie set off for the pet shop.

"I wonder what the best route to the Robot Pet Shop is," pondered Karlie. Just then, they heard a voice from up in a tree. It was a robotic owl perched on a branch.

"Hiya kids!" said the owl. "I see you've found Raleigh, our little robotic rabbit. This is Roy Rossum from Roy Rossum's Robot Pet Shop. I'm talking to you wirelessly from my shop through the communication system in this robotic owl. Any-whooo, thanks for finding my rabbit! I've been tracking it with this owl robot — which has excellent telescopic vision, by the way — but I had lost sight of it until I spotted it in your carrot patch."

"No prob," said Ty. "Glad to help. If we bring the bunny back to you, can we get a tour of your shop?"

"That would be wonderful! Just follow the owl!" replied Mr. Rossum's voice, from the robot.

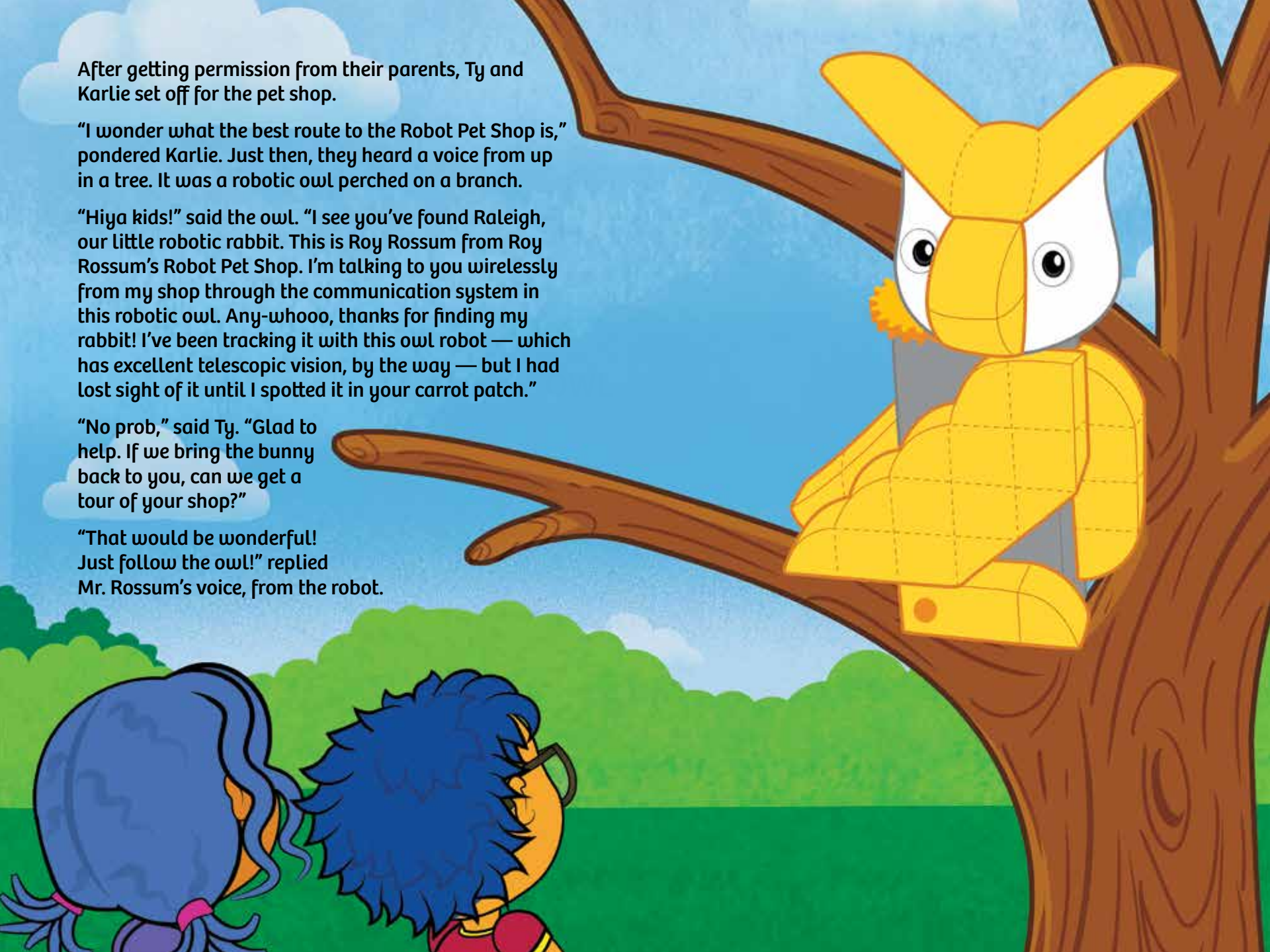

OLIVER THE OWL

1

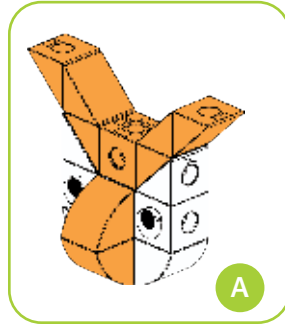
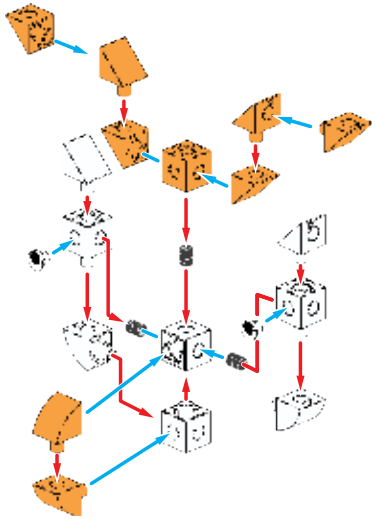

2

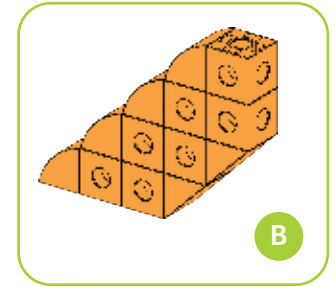
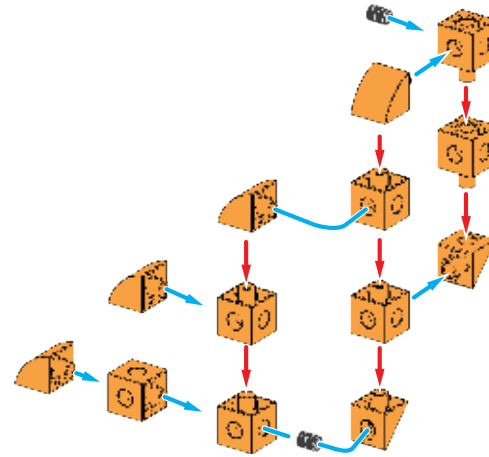

3

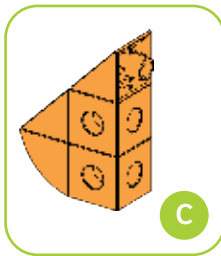
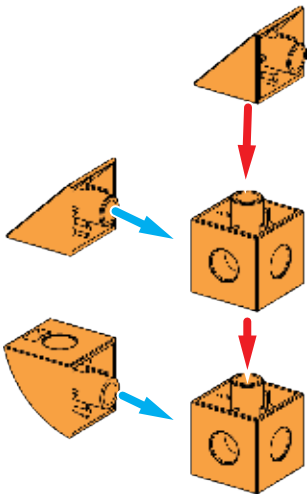

4

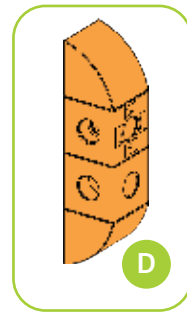
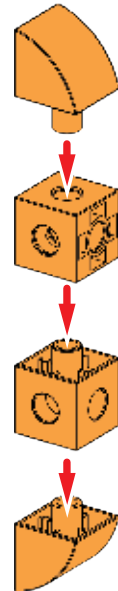

5

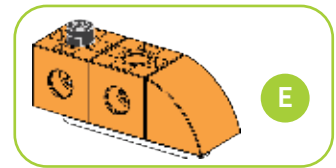
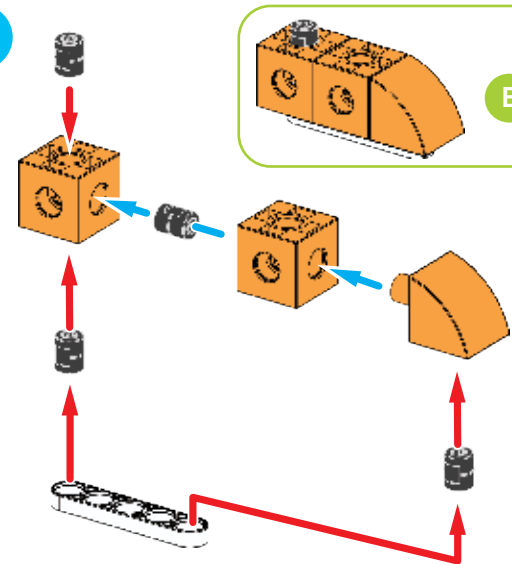

6

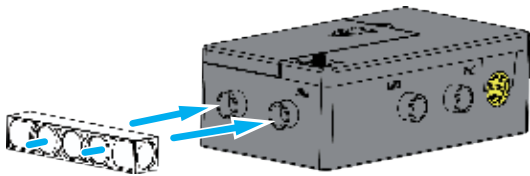
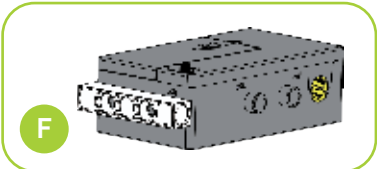

7

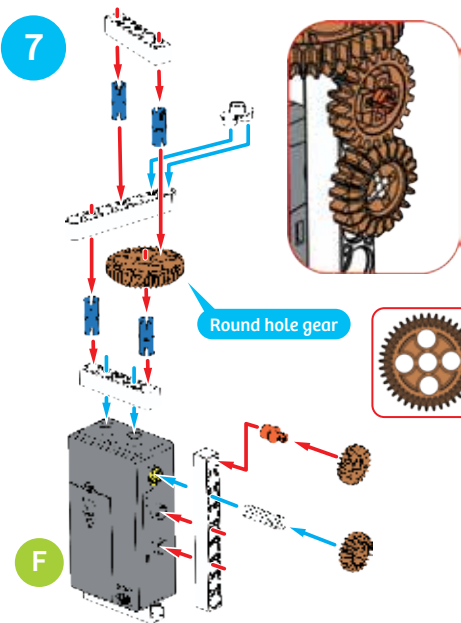

Pay close attention to the orientations of the gears here.

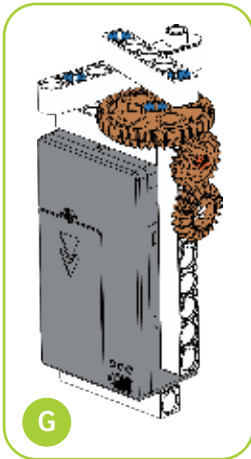

8

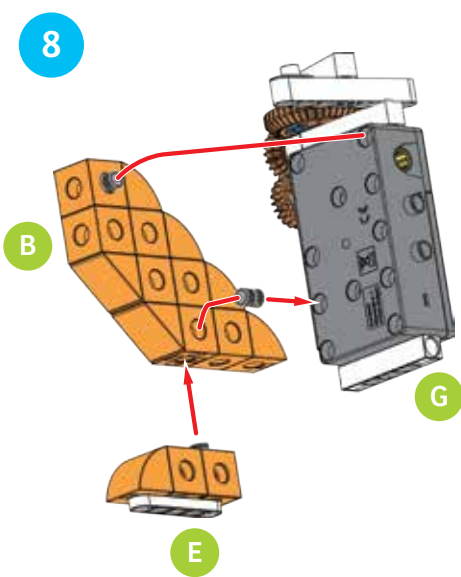

9

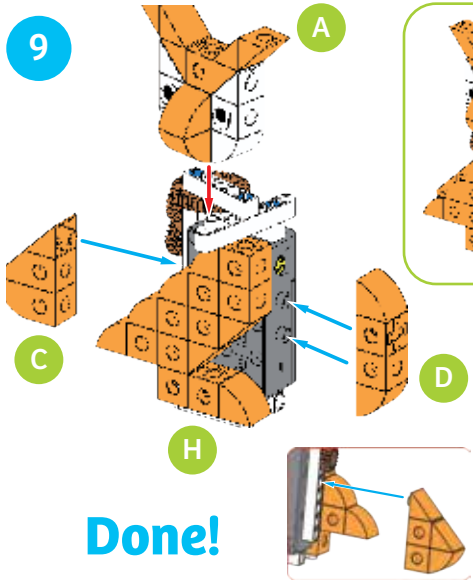

Done!

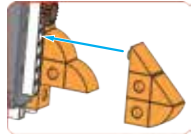

Left side

The model of Oliver the Owl turns its head from side to side in a reciprocating (which means back-and-forth) motion. There are two cool mechanisms in this model that make this happen. First, the gear train that transfers motion from the motor inside the motor box to the medium gear uses bevel gears to "turn the corner" and change the axis of rotation. Second, a rod is connected to the medium gear such that when the gear turns, the rod moves back and forth, shaking the owl's head. This device is called a crank.

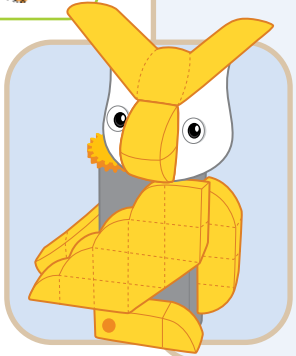

Karlie — who was cradling the bunny robot — and Ty followed the owl to a small, blue storefront in downtown Makersville. “Roy Rossum’s Robot Pet Shop” was printed in small silver lettering on the door. They went inside.

It smelled a little more like a toy store than a pet shop, but a few animals scurried about as they entered. A cute robotic kitty cat rubbed up against Ty’s leg and purred. Karlie was pretty sure the purring was actually the sound of gears whirring inside the cat.

“Hi there! I’m Roy Rossum,” Mr. Rossum said with a smile. “Thanks for bringing Raleigh back. Now, how about that tour? Did you know that our offerings go far beyond common pets like cats and dogs? We have all sorts of cool robotic pets!”



CLARISSA THE CAT

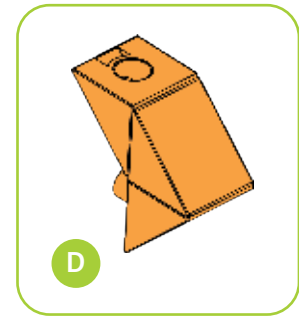
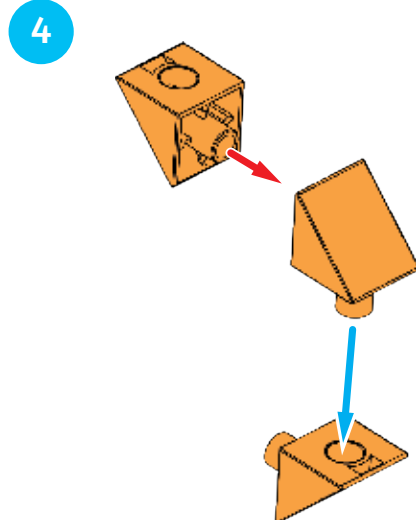
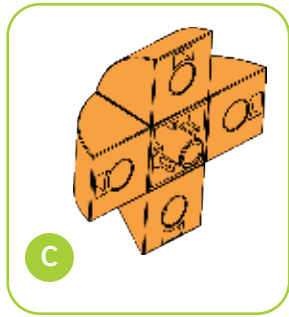
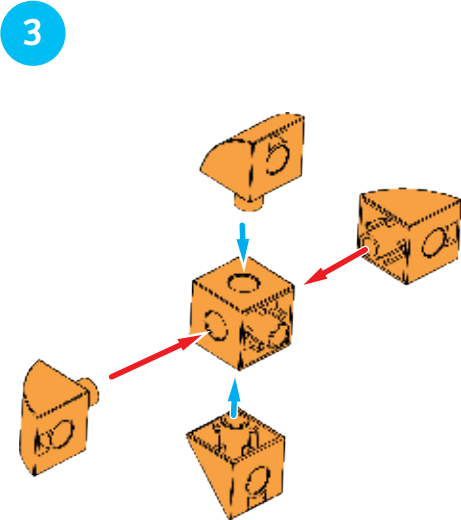
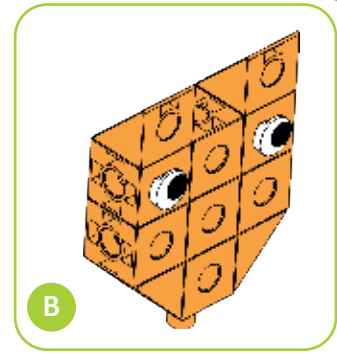
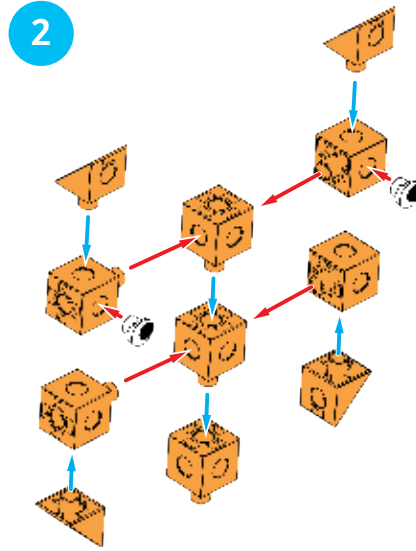
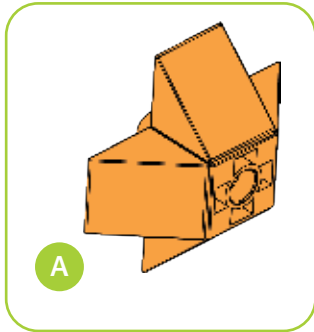
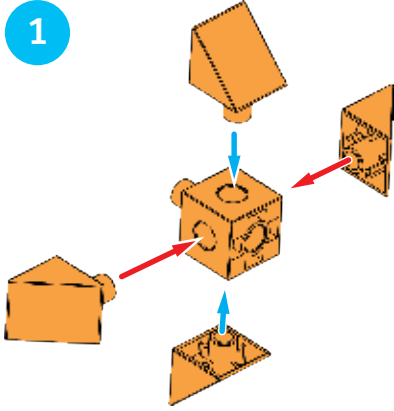

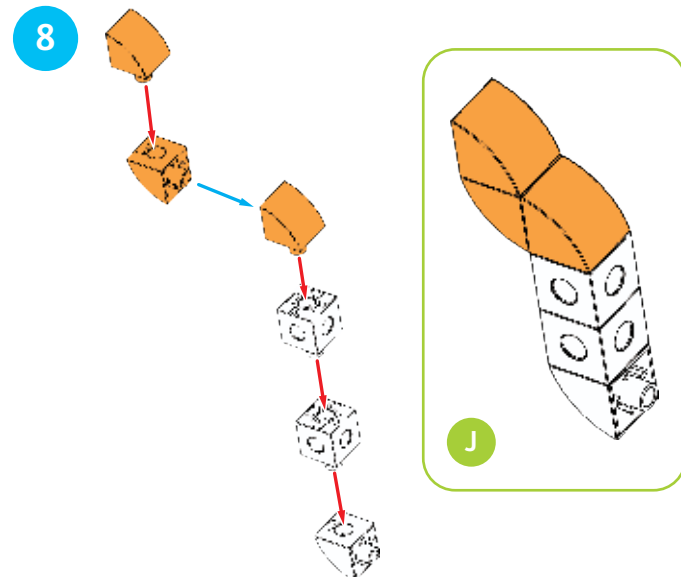
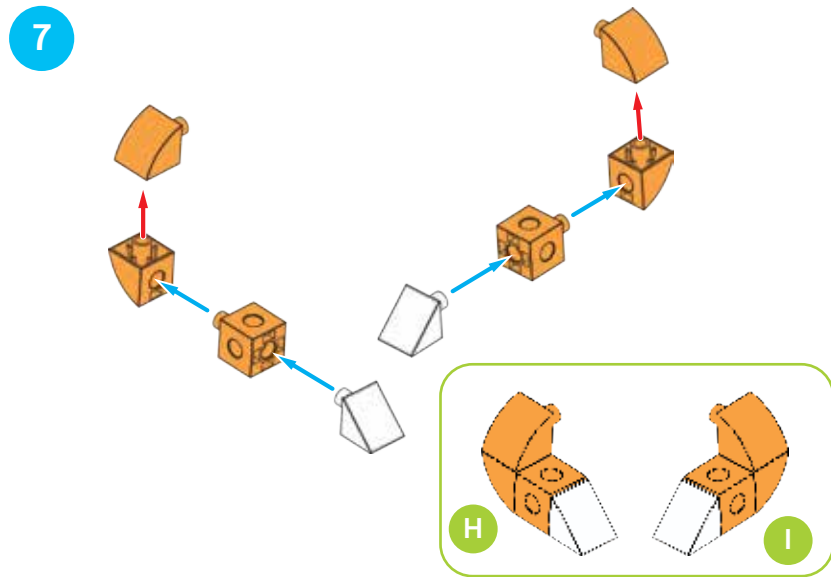
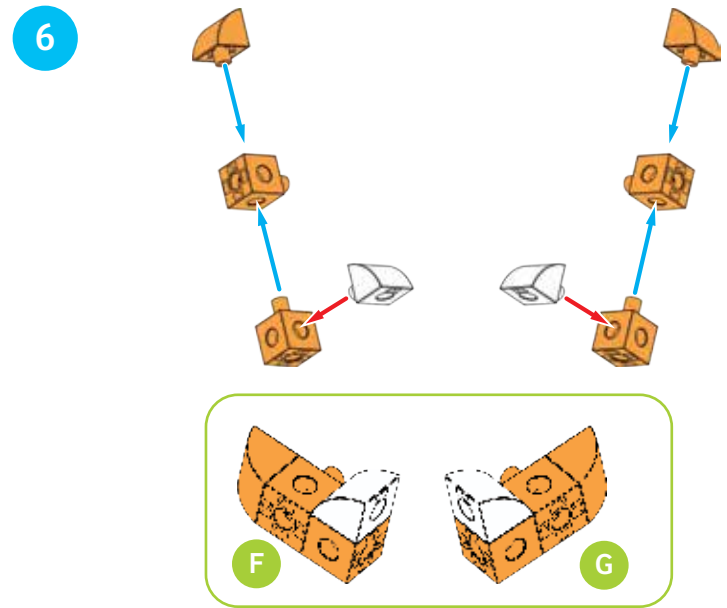
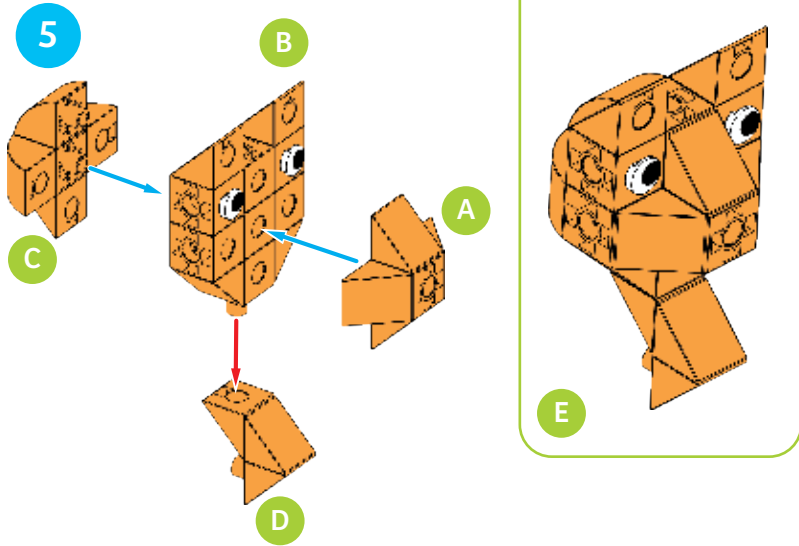

9

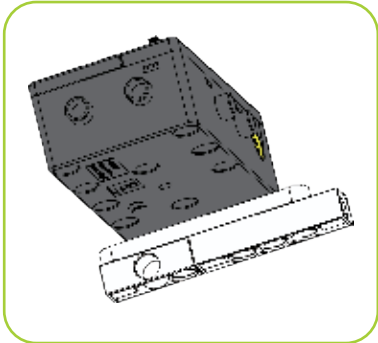
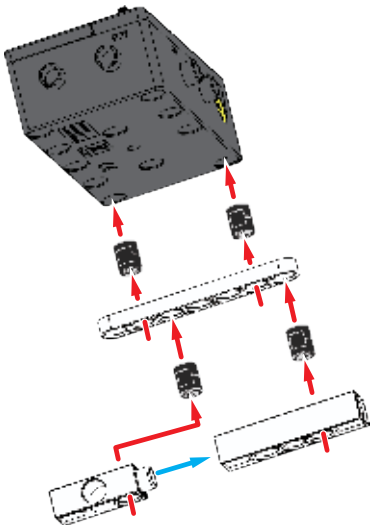

10

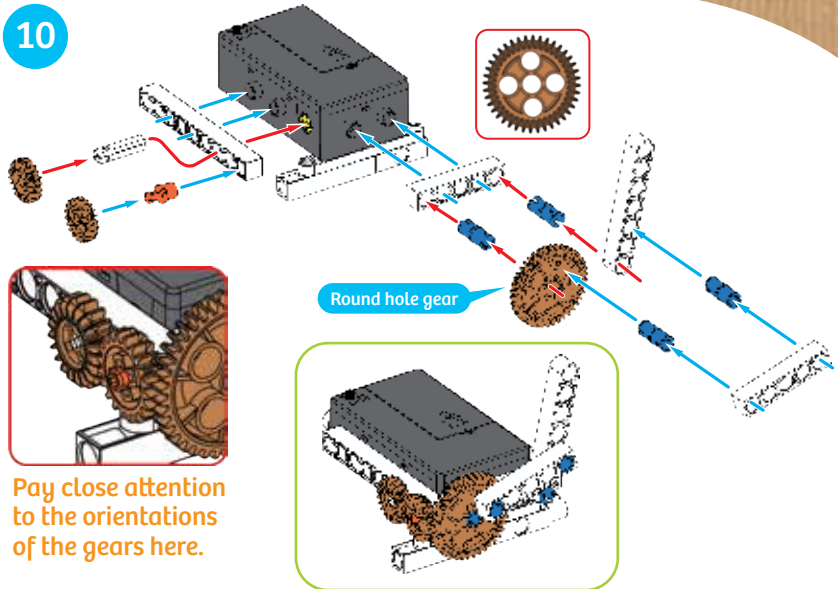

Pay close attention to the orientations of the gears here.

11

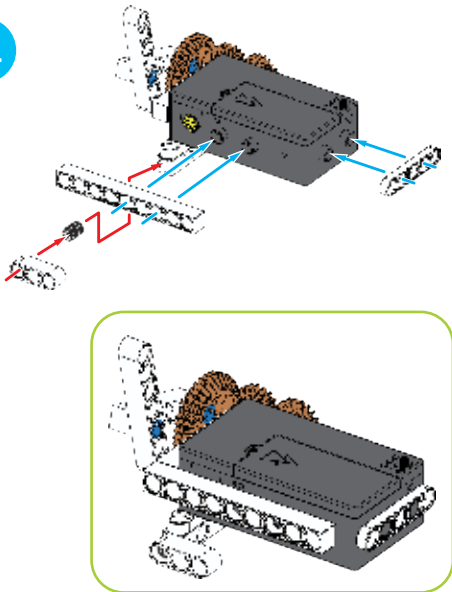

12

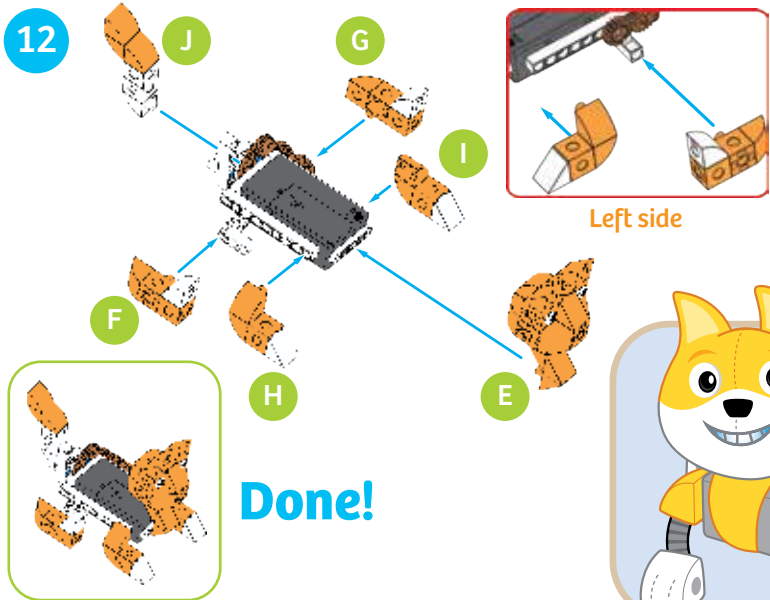

The model of Clarissa the Cat wags its tail back and forth. Have you seen this type of motion before? A very similar mechanism was used in the owl model! Here, the crank makes the cat's tail move back and forth. What happens when you reverse the direction of the motor?



The kids followed Mr. Rossum through a big golden door. They gasped in awe. Behind the modest storefront was an enormous factory workshop with dozens of different habitat zones. From the entryway, Ty and Karlie could see a forest, a jungle, a beach, a desert, an aviary, a number of aquarium tanks, and even a living room setup — as well as countless industrial machines and computers.

They walked over to a pond area where a robot turtle was sunning itself under a skylight. Mr. Rossum explained that the turtle's shell was specially designed to protect the electronics inside the robot, just like a real turtle's shell protects it from harm.



TANYA THE TURTLE

1

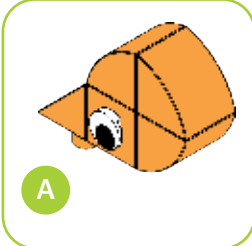
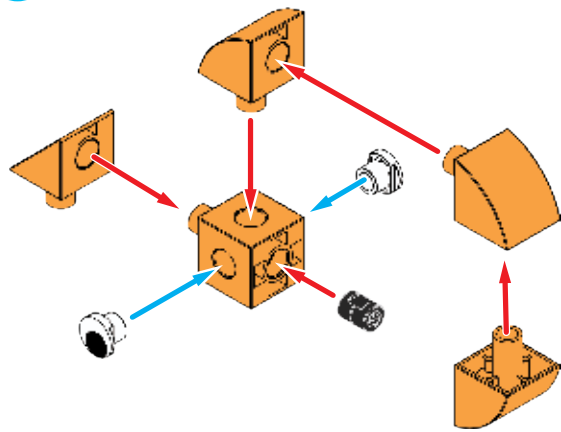

2

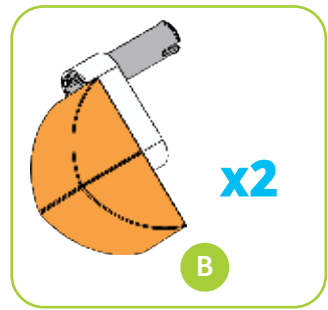
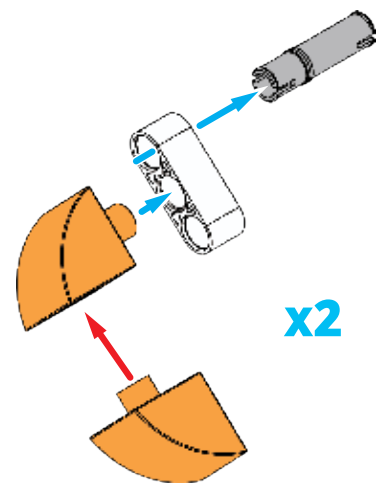

3

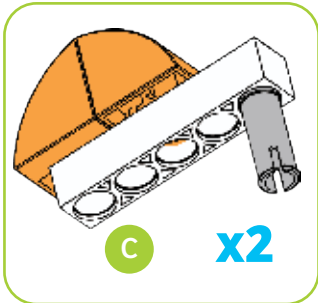
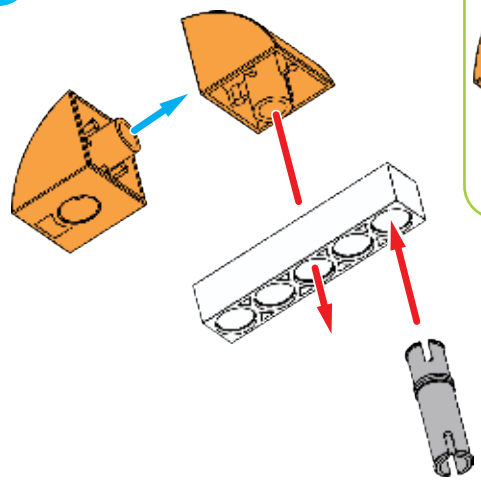

4

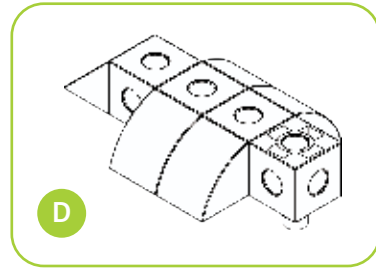
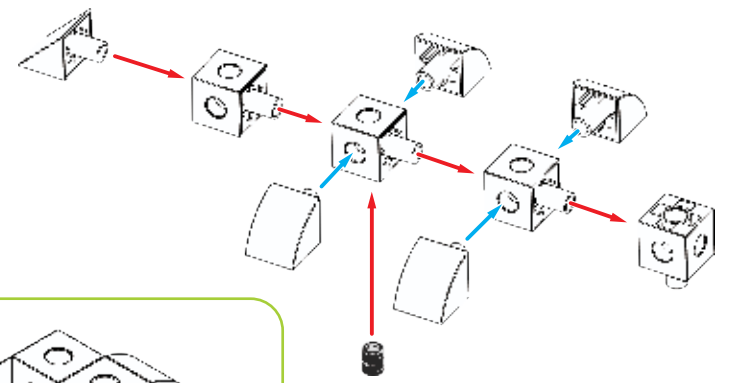

5

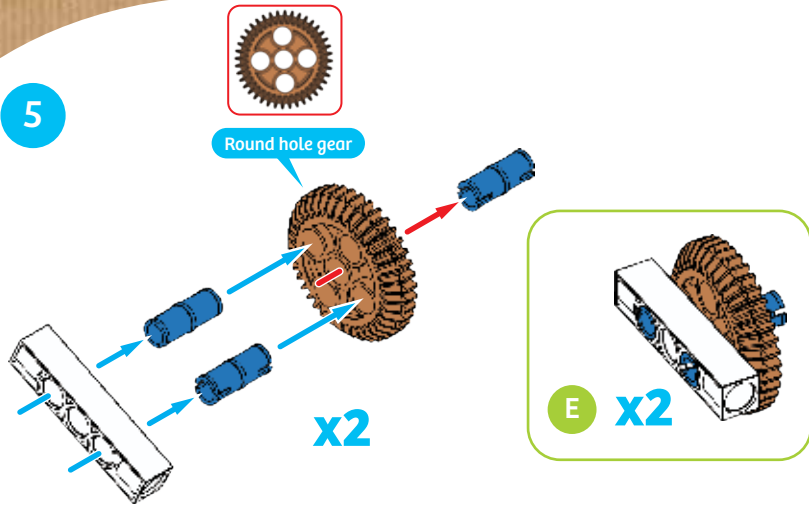

6

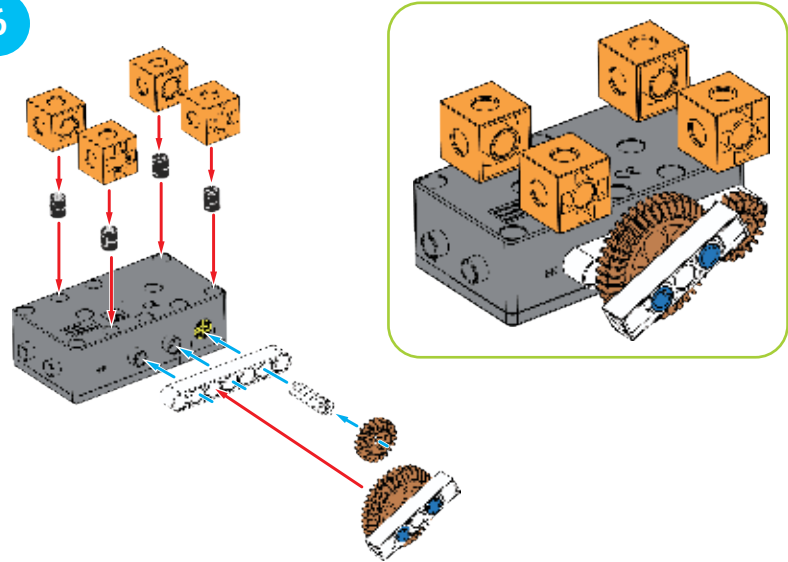

7

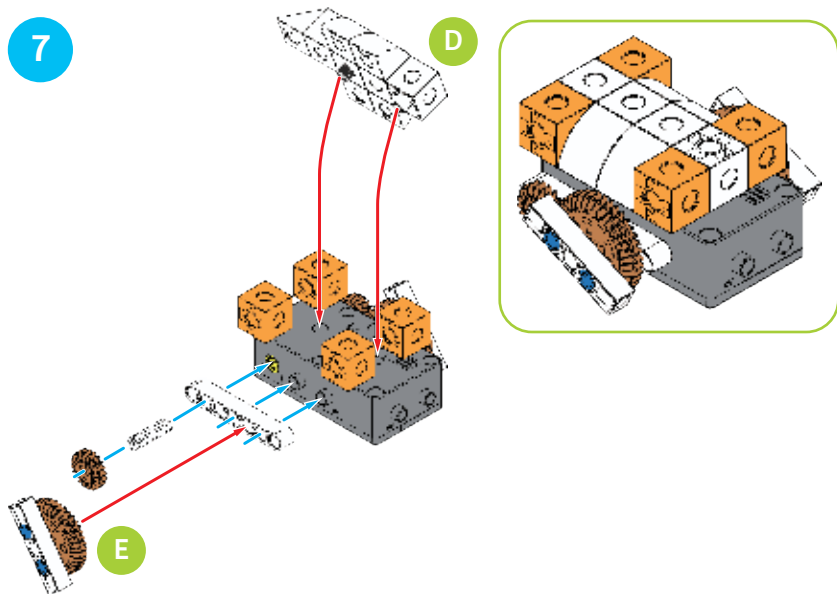

8

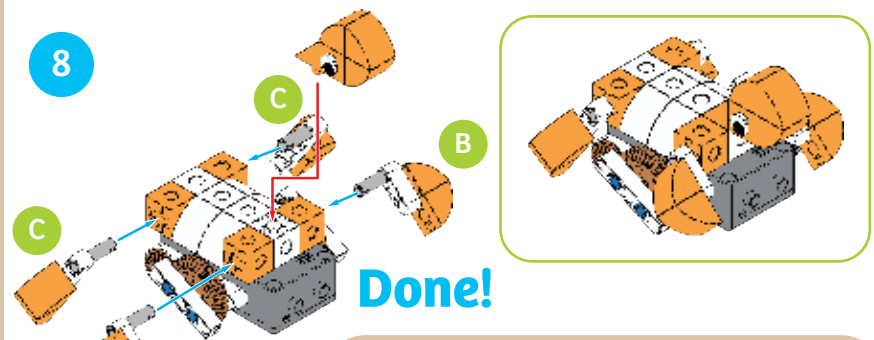

Done!

The model of Tanya the Turtle scuttles along in a jerky motion due to the rods attached to the medium gears. The rods also tap against the legs, making the legs kick as the model rolls forward.

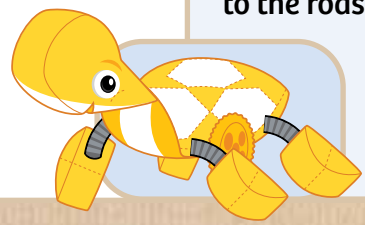

Ty and Karlie followed Mr. Rossum away from the pond area and down a long hallway.

"I'm quite proud of this robot," Mr. Rossum said, gesturing to the blue wall. The kids were confused because they couldn't see anything.

Just then, a chameleon became visible on the wall.

"Chameleons can change color to blend into their surroundings," said Mr. Rossum, "so we designed this pet chameleon robot to change color too. And it has sticky feet that allow it to stick to vertical surfaces!"

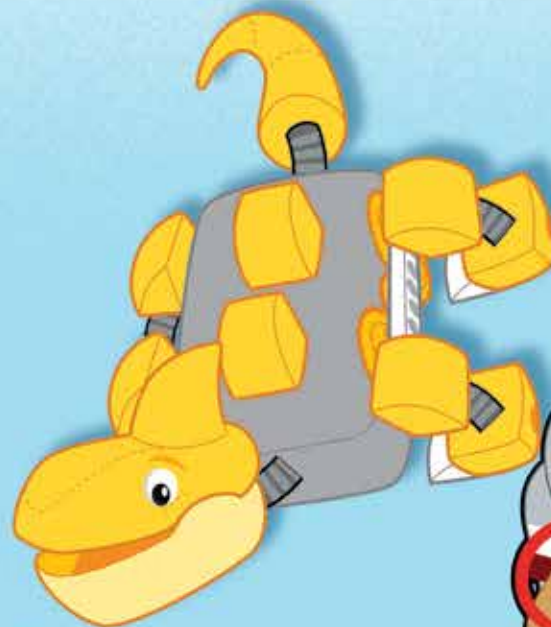

CARMEN THE CHAMELEON

1

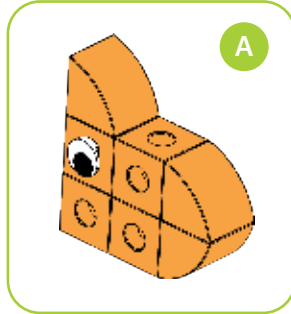
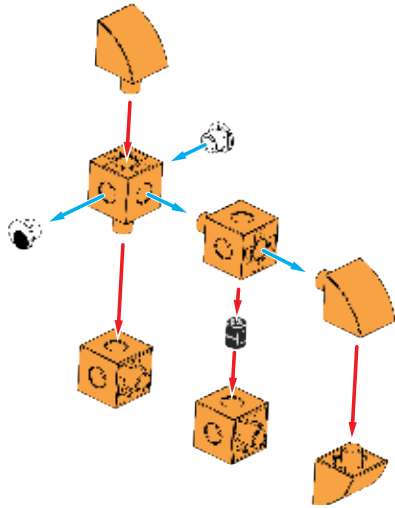

2

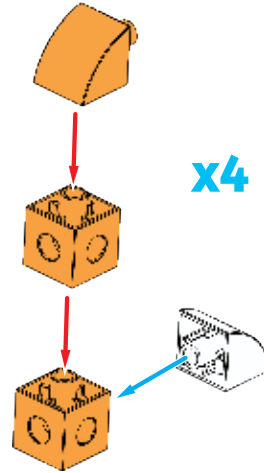

x4

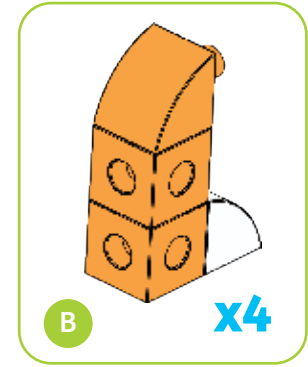

3

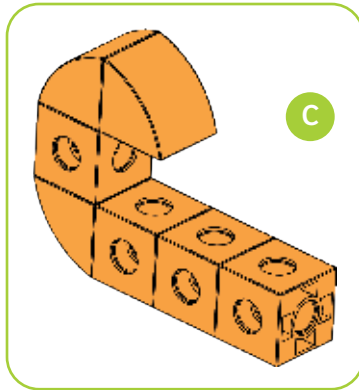
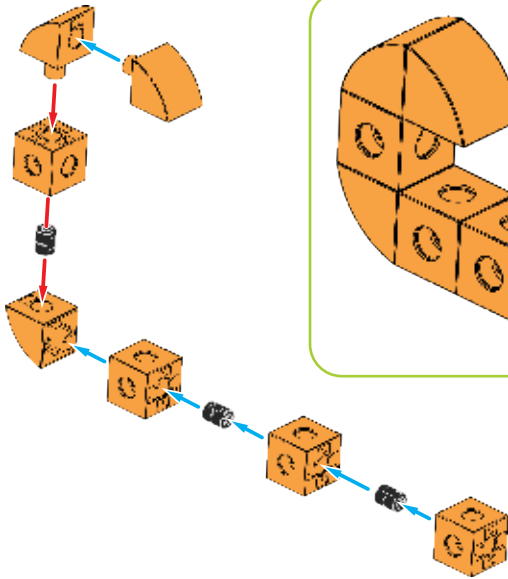

4

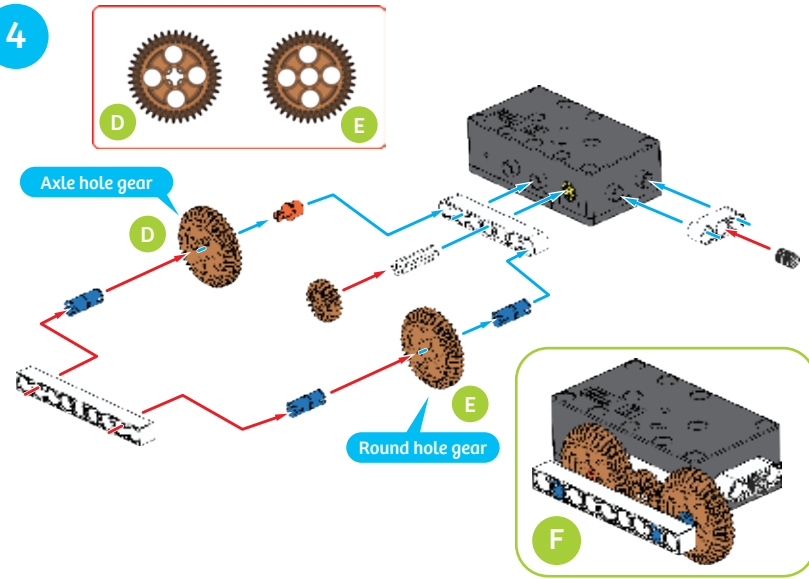

5

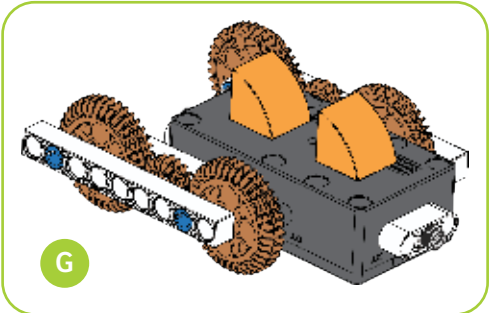
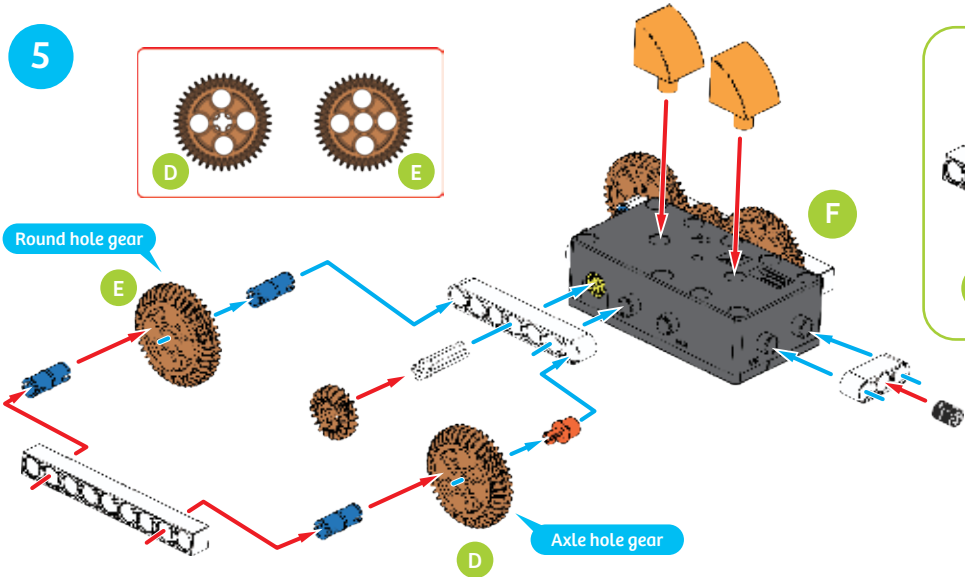

6

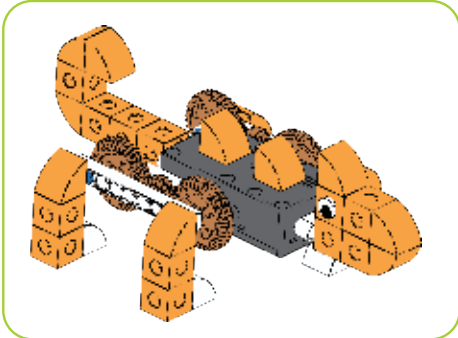
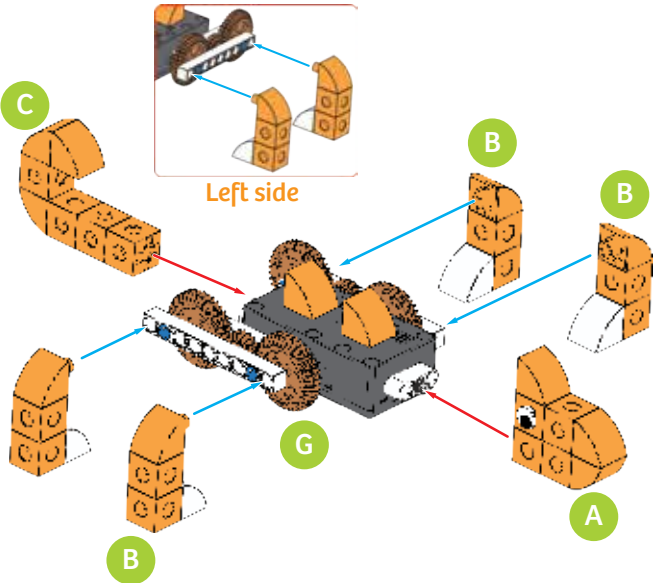

Done!

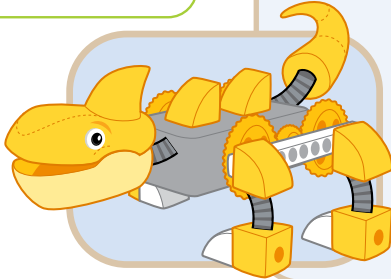

The model of Carmen the Chameleon doesn't actually have color-changing skin like a real chameleon, but it does perform a little dance on its four legs. The legs are connected to the 9-hole rods which are connected to the medium gears on both sides of the model. When the legs on one side of the model are lifted up, the legs on the other side of the model are down.

This makes the model wiggle around and dance in place when the motor is turned on. Carmen is one happy chameleon!



The tour continued into a forest habitat, where a robotic sloth was hanging motionless on a tree branch.

“When we first designed the sloth robot, it moved much too fast,” explained Mr. Rossum, “so we changed its gearing and reduced the power and now it basically just hangs around all day. Quite realistic, no?”

SILAS THE SLOTH

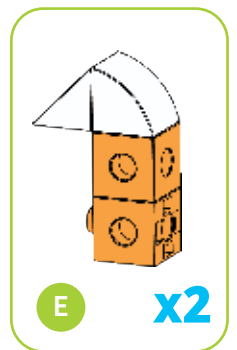
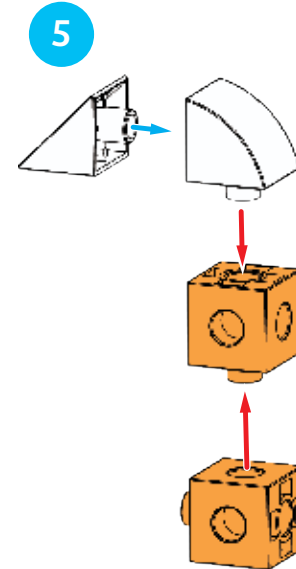
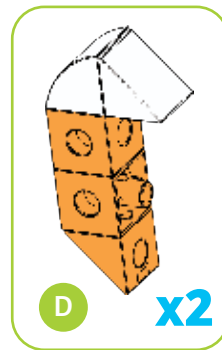
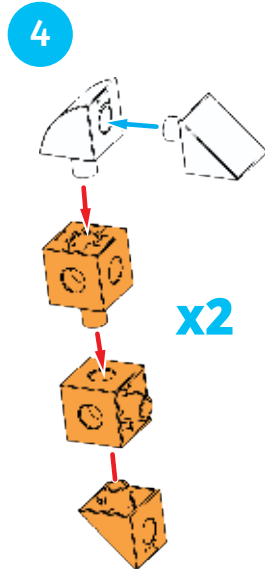
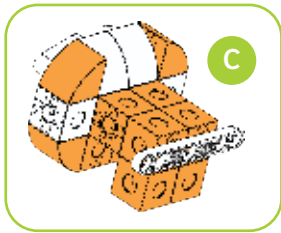
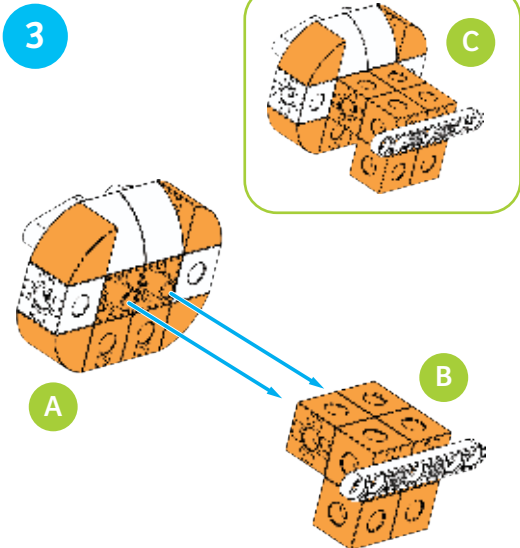
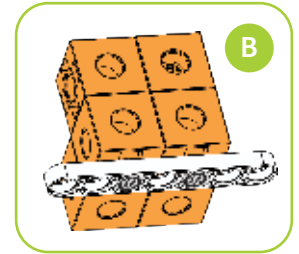
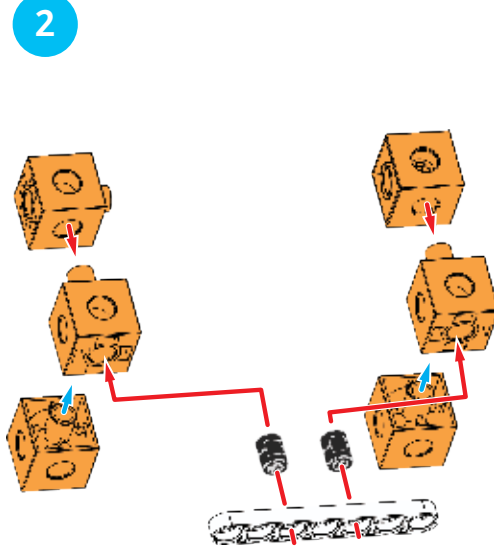
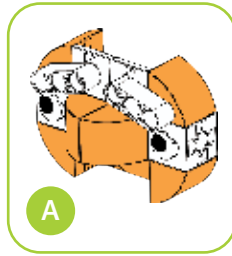
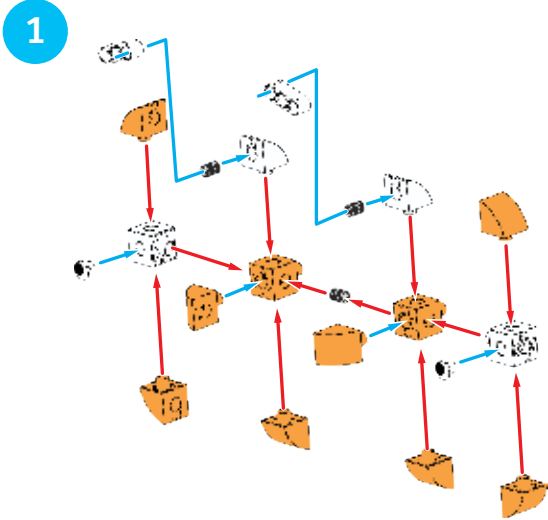

6

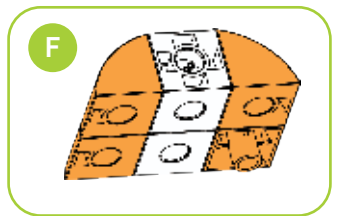
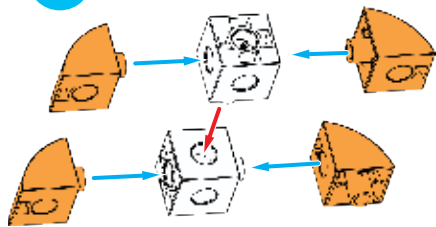

7

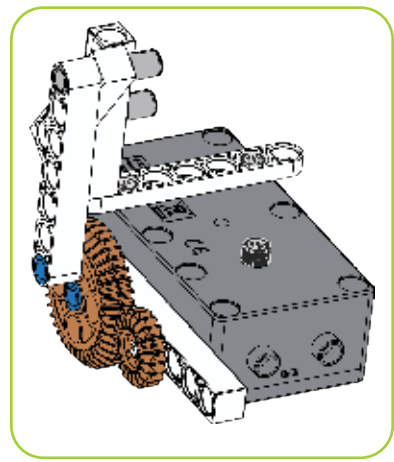
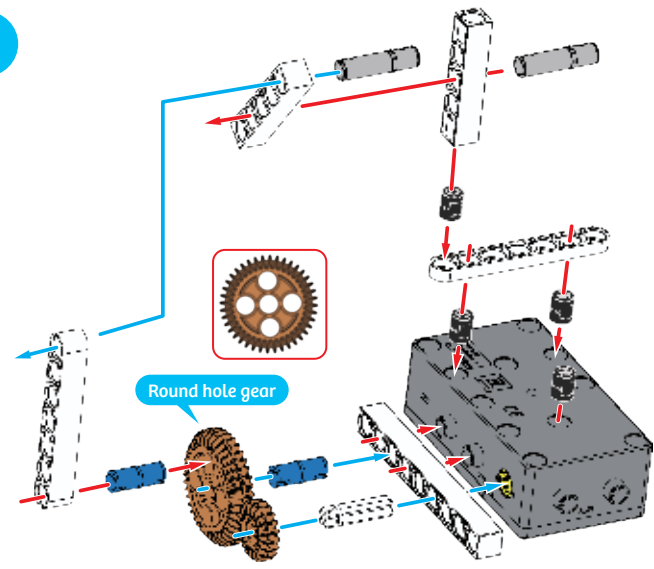

8

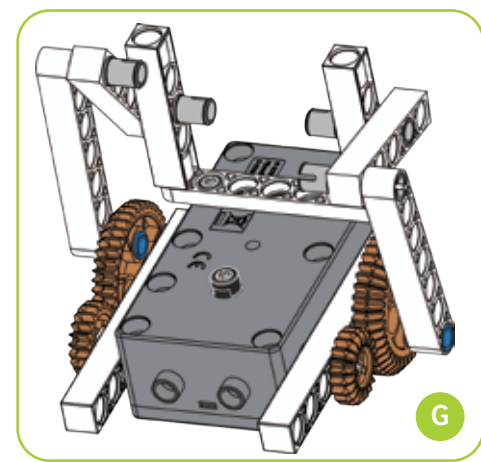
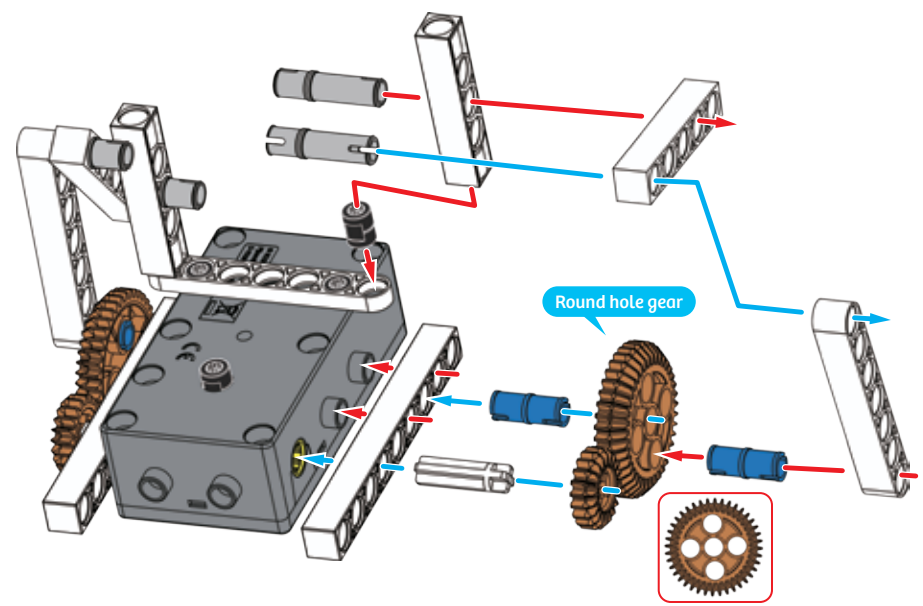

9

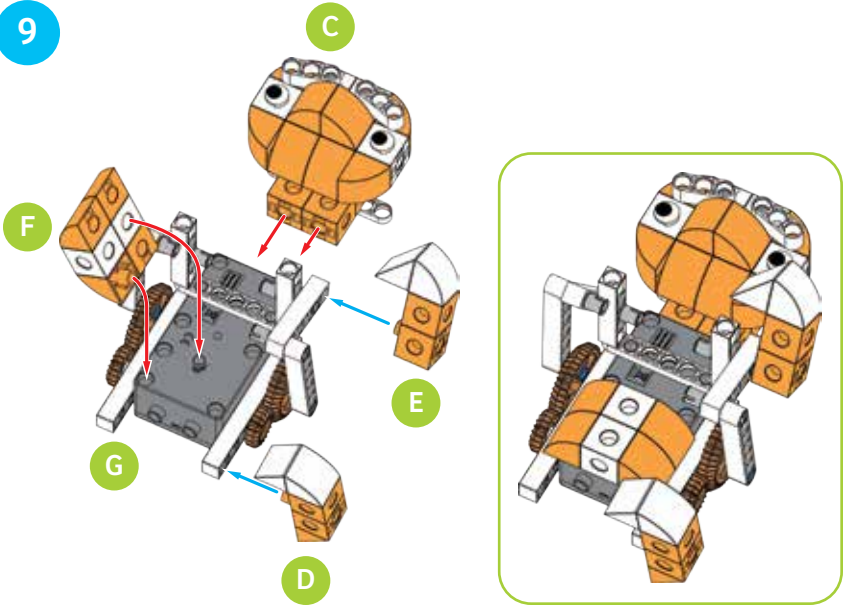

10

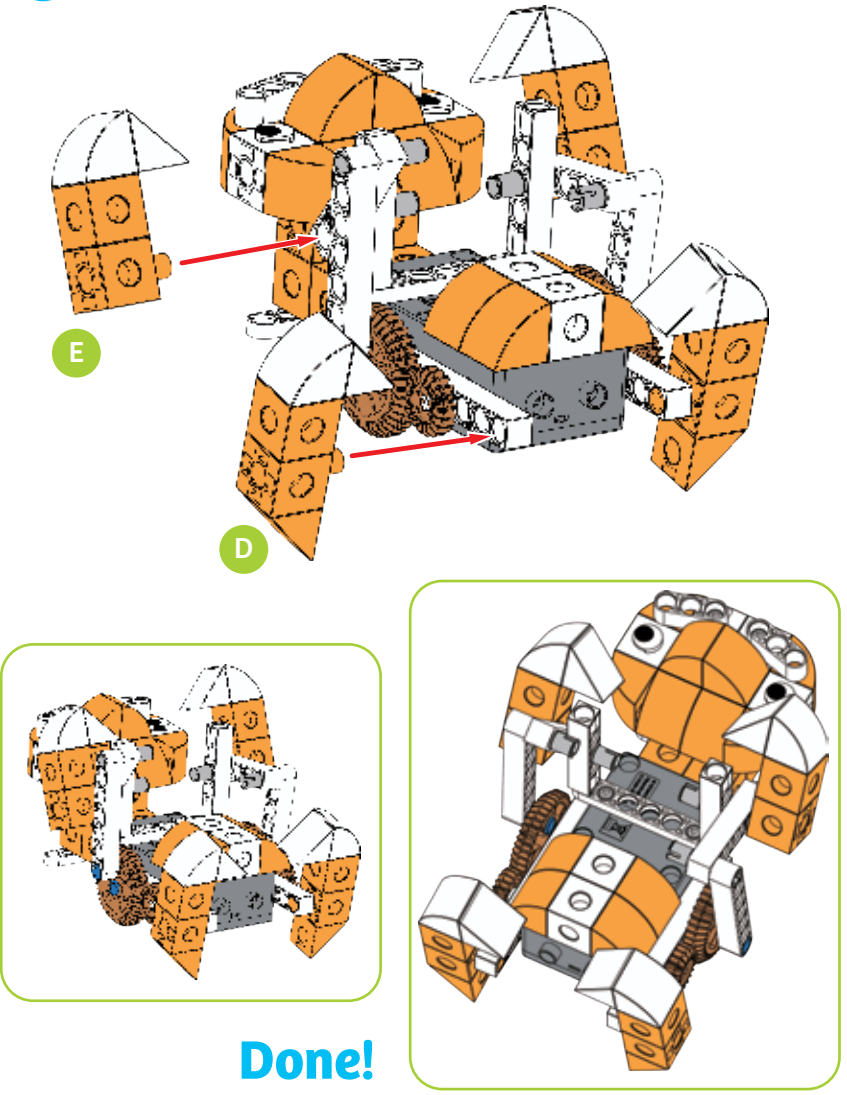

The model of Silas the Sloth is a silly model indeed. The sloth is on its back, with its legs sticking up in the air. The front legs move back and forth because cranks on both sides of the motor box transfer the rotating motion of the medium gears to the reciprocating motion of the legs. You can see that the crankshafts connected to the medium gear wheels are actually connected to another rod, which is then connected to the legs. This type of setup is called a linkage, where two or more movable rods are linked together. Linkages are used almost everywhere in engineering.

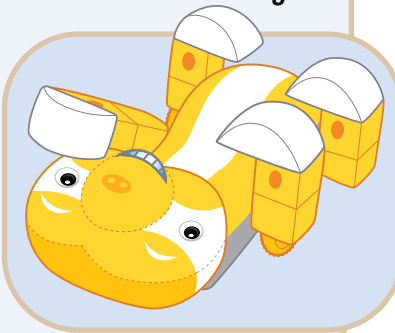

Done!

The kids followed Mr. Rossum into a thick grove of bamboo. In the middle, there was a cute panda robot, chomping away on a bamboo stalk.

“Real pandas eat up to 40 pounds of bamboo a day,” Mr. Rossum said. “We designed this panda robot to eat just as much. Fortunately, bamboo grows really fast. But most excitingly, the robot automatically makes paper from the pulp of the chewed up bamboo!”

“That’s amazing!” shouted Karlie.



PENELOPE THE PANDA

1

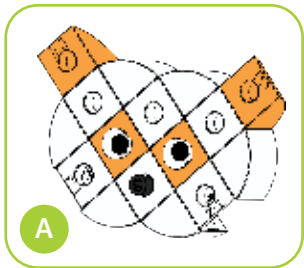
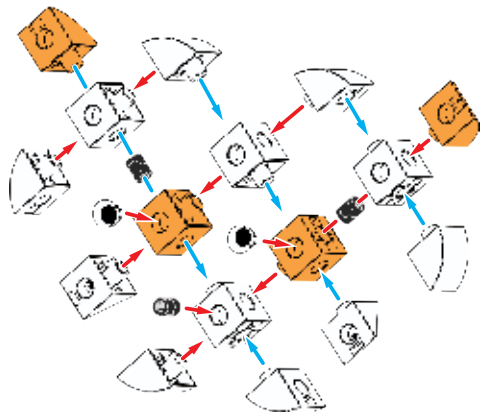

2

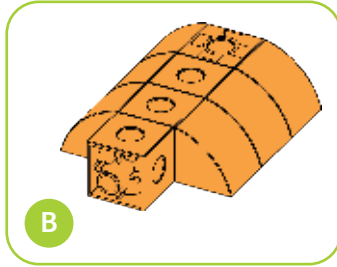
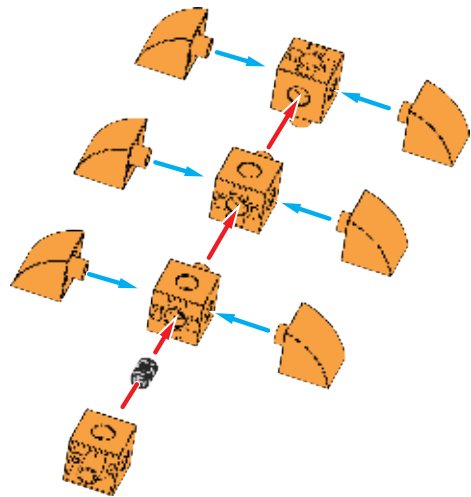

3

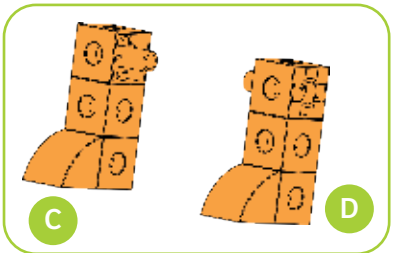
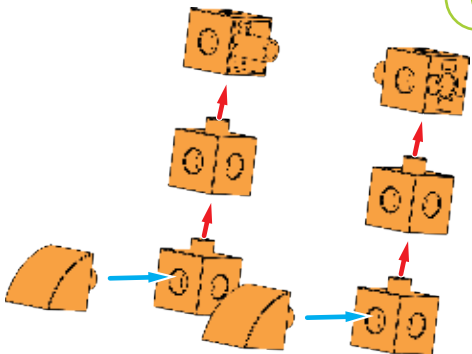

4

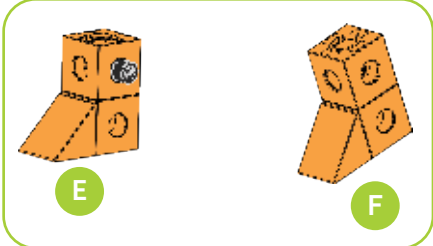
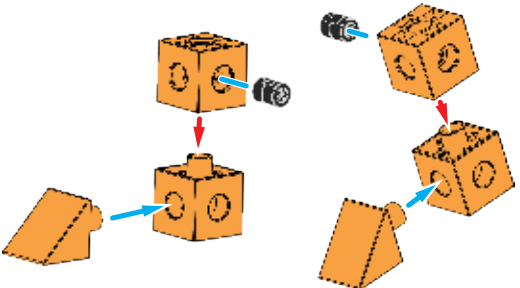

5

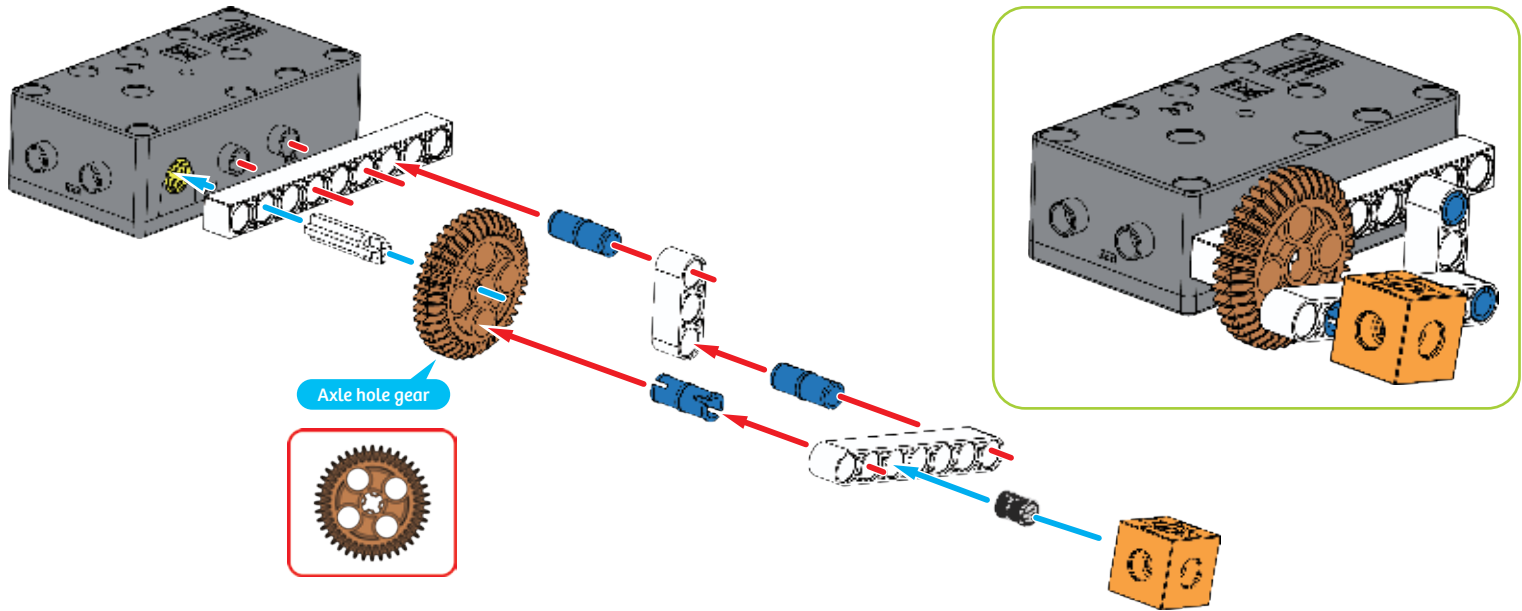

6

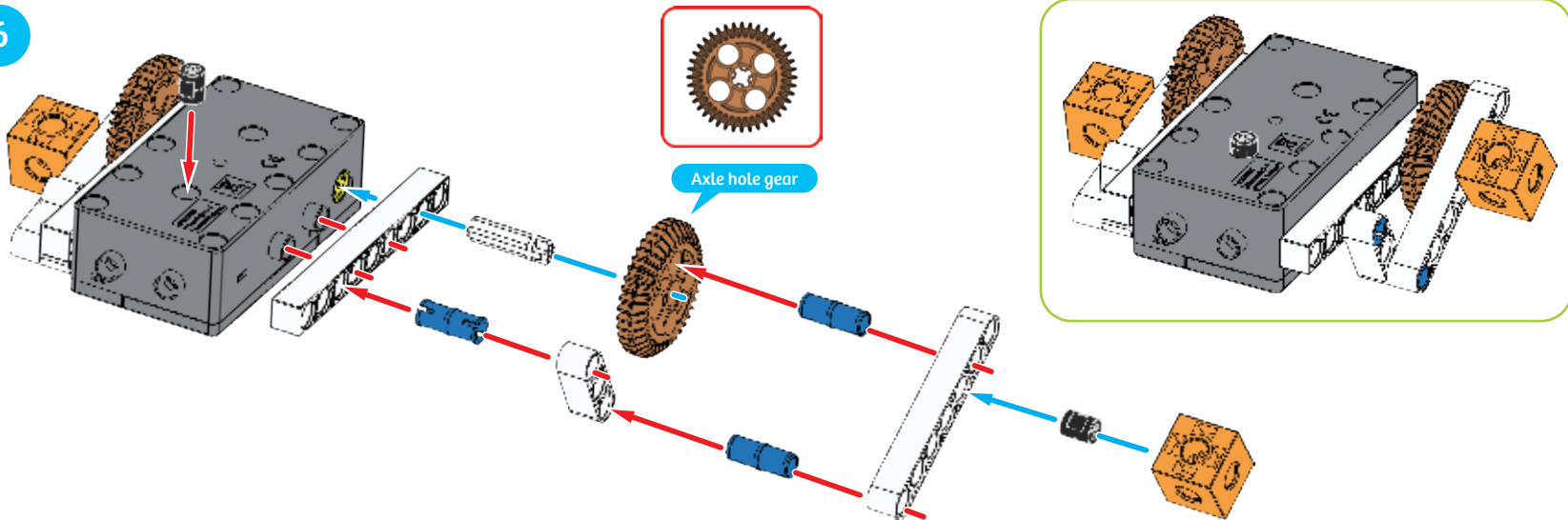

7

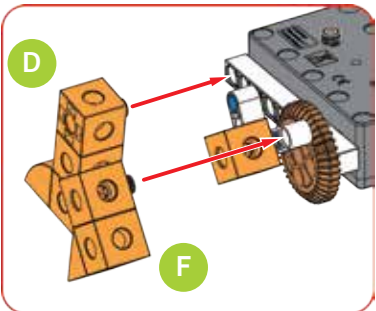
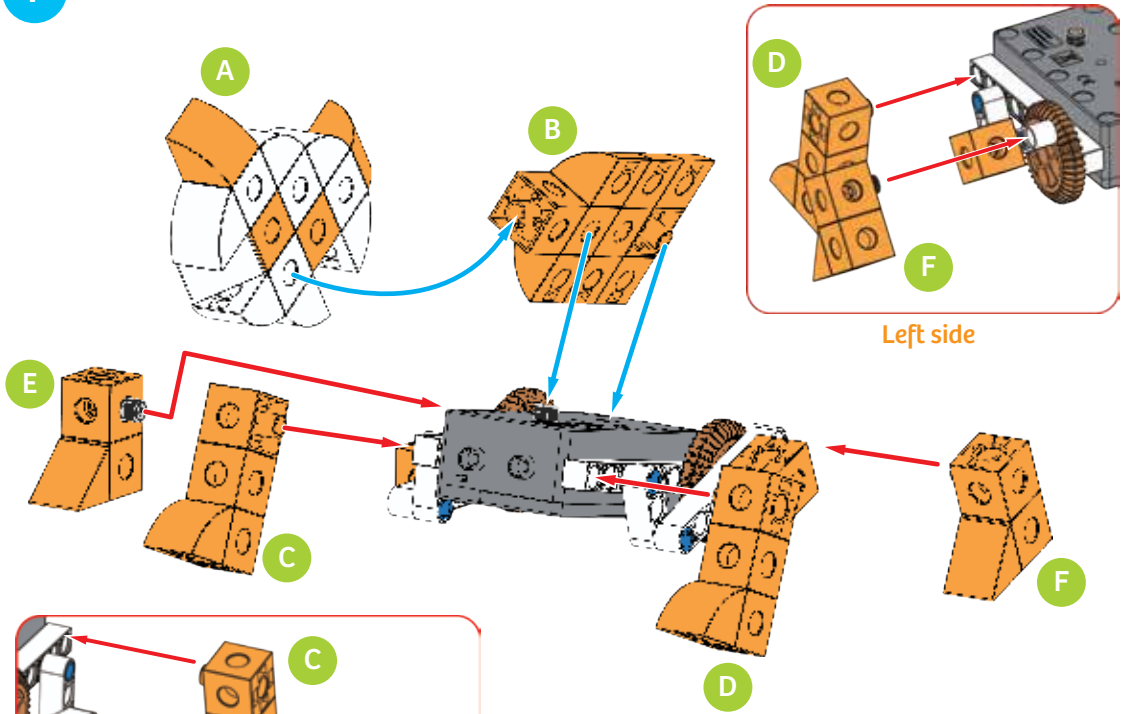

Left side

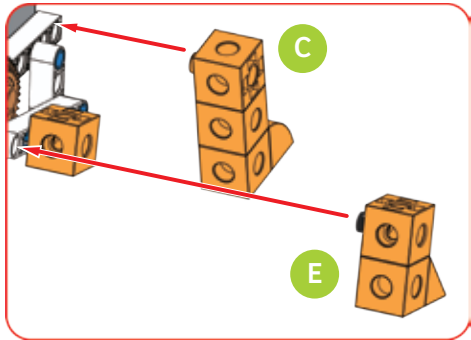

Right side

Done!

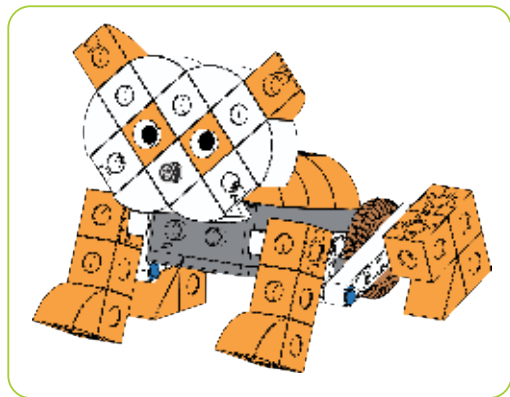

The model of Penelope the Panda walks forward using a clever mechanism: Look closely and you'll see that when one of the hind legs is pushed forward, the other one is pulled back. This allows the model to move forward, step by step. Can you find a linkage in the model? Can you find a crank?



EXIT

The group came to another golden door, which lead back into the storefront.

"Thanks for showing us around your pet shop," said Ty. Just then, he spotted an adorable French bulldog robot on a workbench. "What's that?"

Mr. Rossum explained that this robotic dog wasn't working and he hadn't been able to fix it yet.

"We can fix it," Karlie offered.

"That would be great, kids," said Mr. Rossum. "I'd love for you to take this robot and make it operational again. Go right ahead!"



FRANKIE THE FRENCH BULLDOG

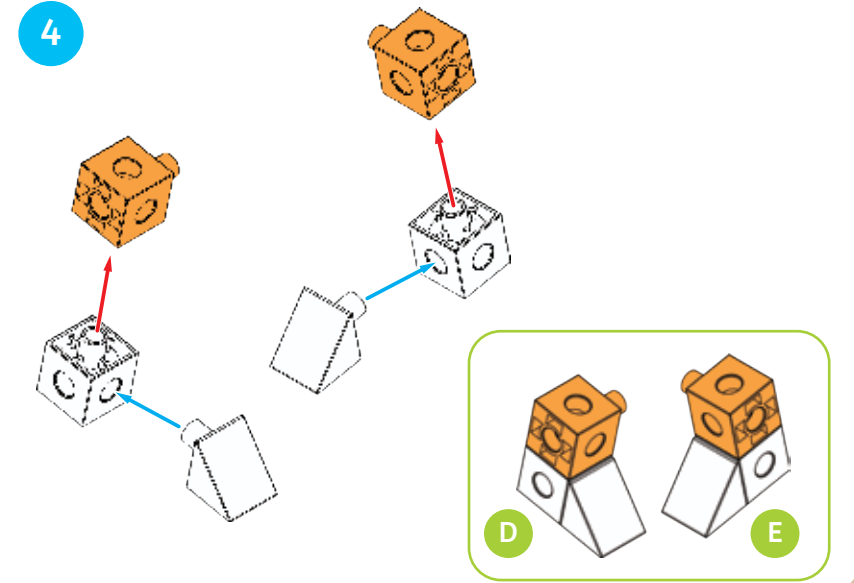
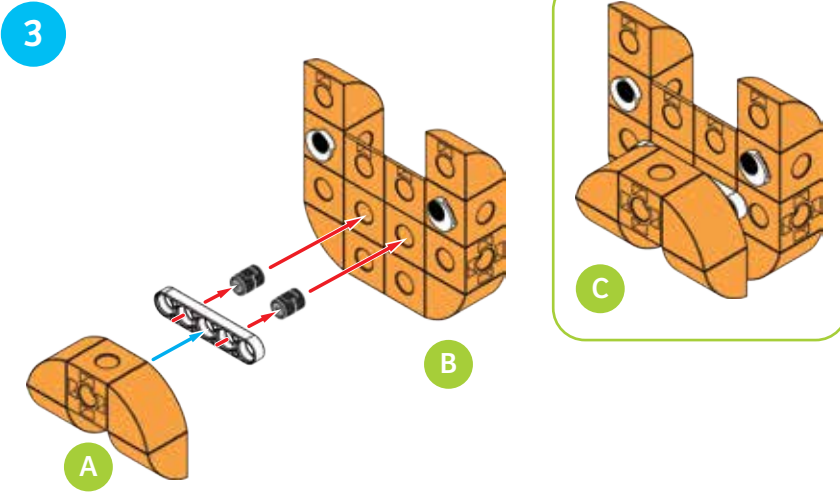
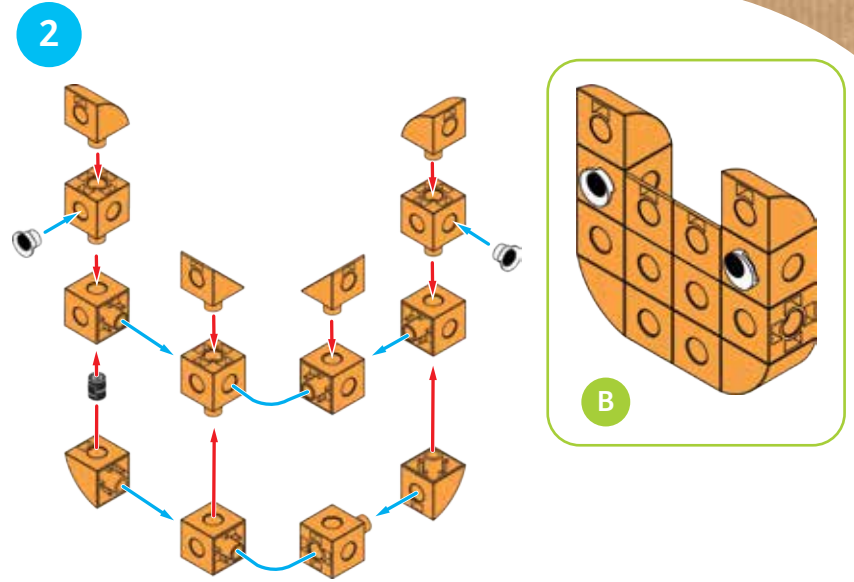
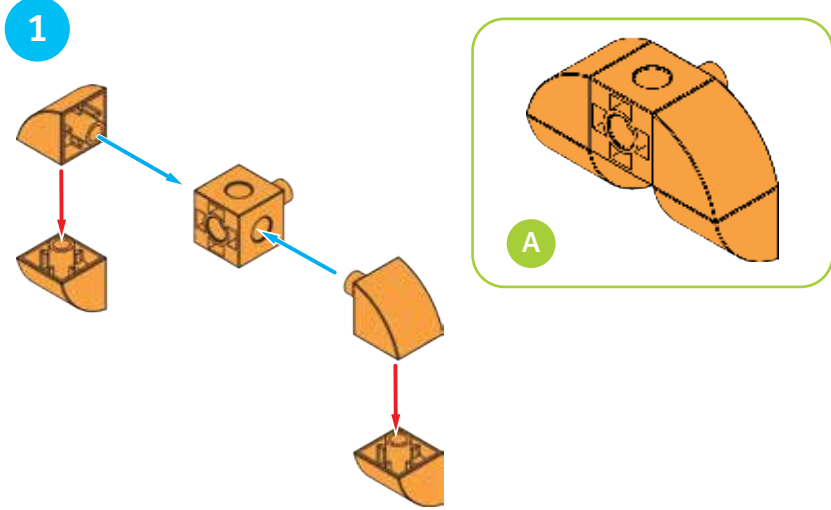

5

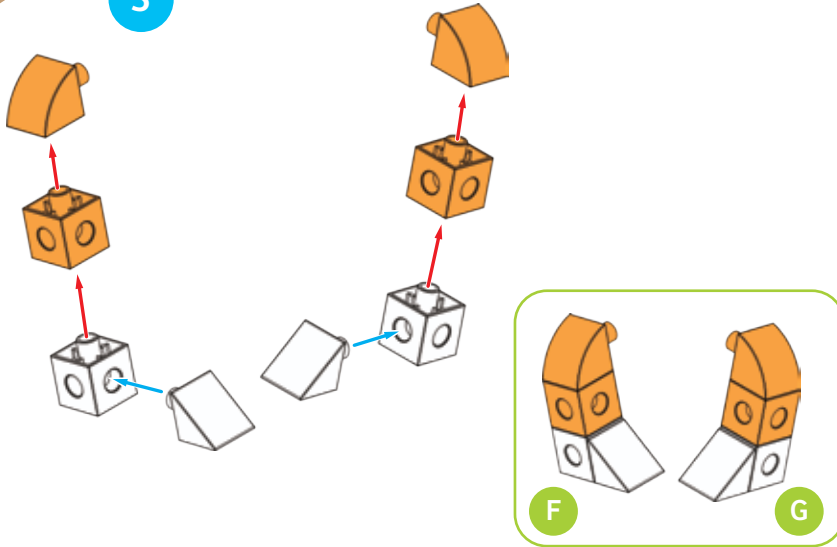

6

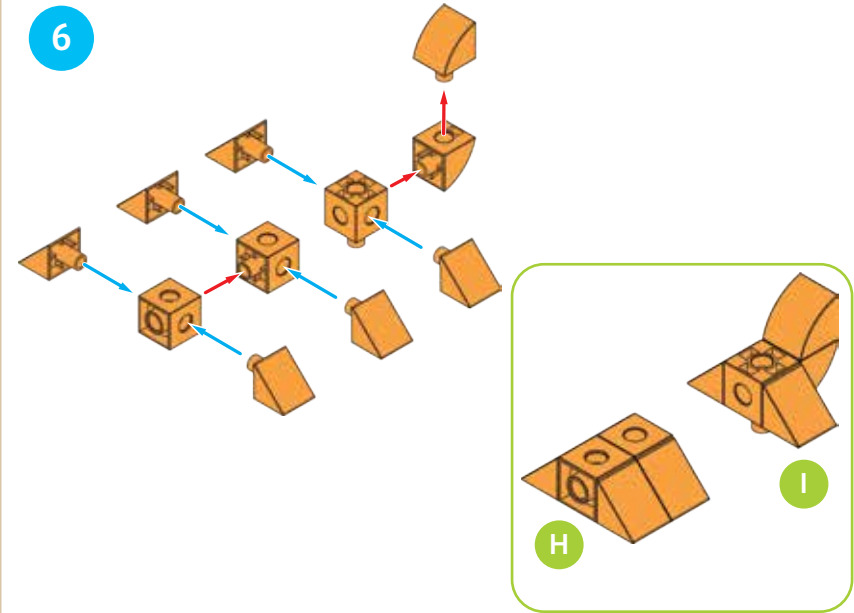

7

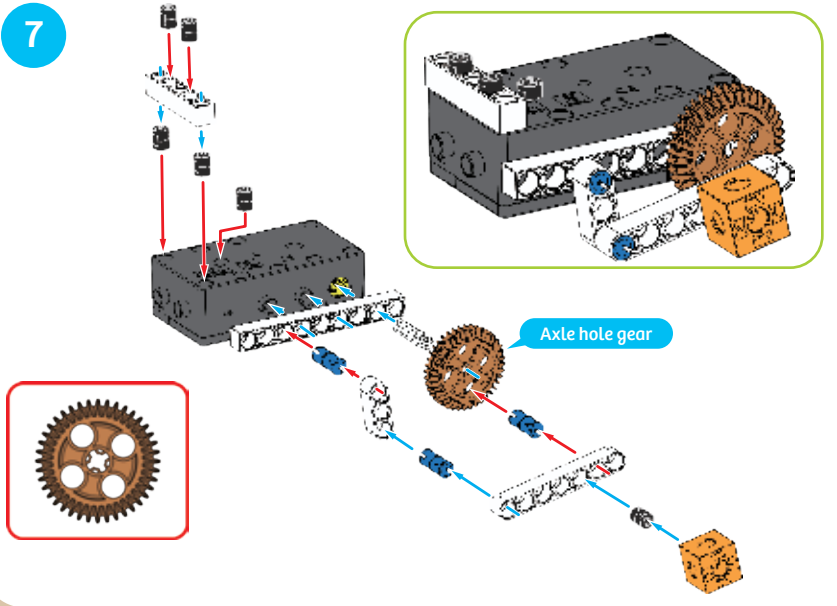

8

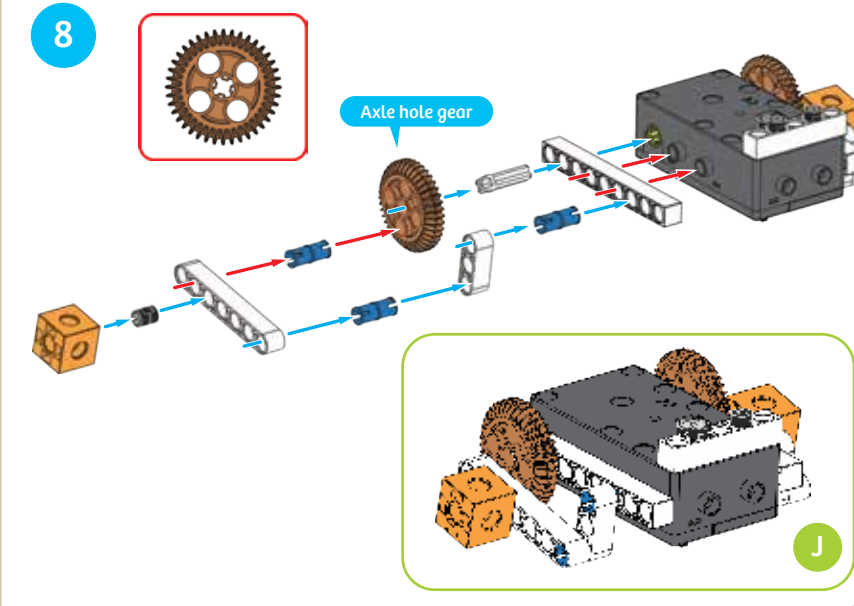

9

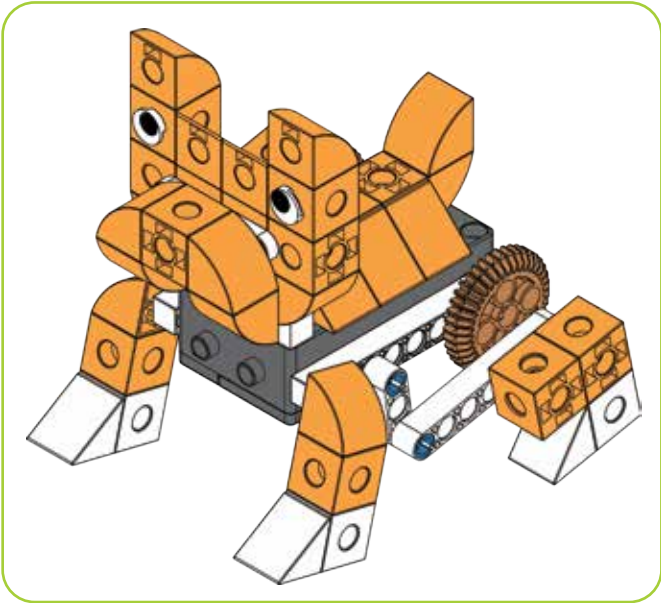
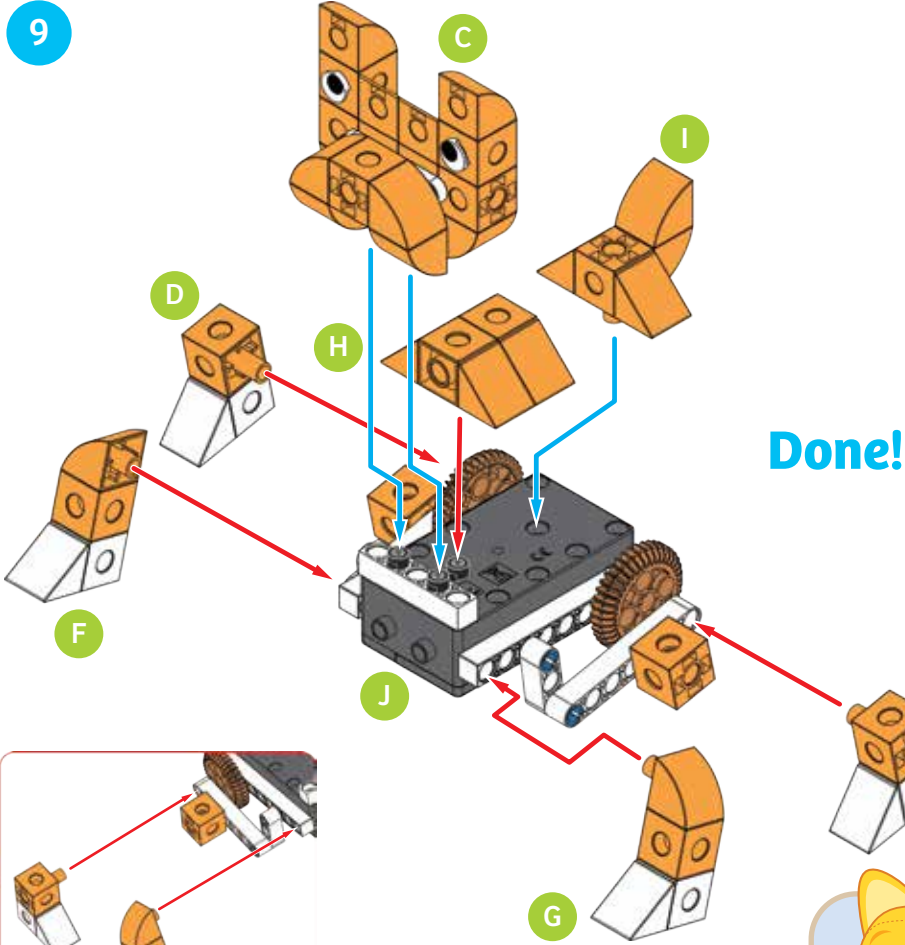

Done!

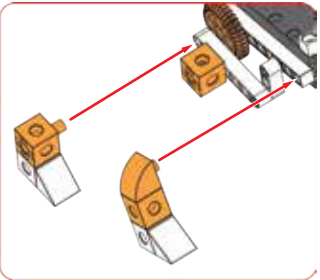

Right side

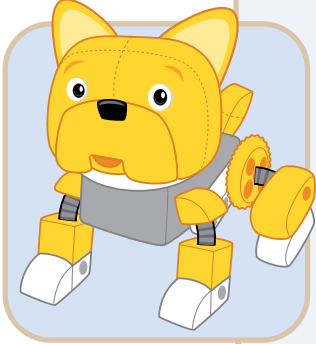

The model of Frankie the French Bulldog moves using a mechanism very similar to that of the panda. The main difference is the look of the models, rather than the functionality of the models. In engineering and design, the look and styling of a product or device is as important as the way it works. Here, we turned a panda into a bulldog. In automotive engineering, often the same car chassis, or vehicle frame, is used for different car bodies. The final cars might look very different but they have the same functional framework underneath.

The kids headed home. With the help of Mrs. Omega — who, coincidentally, has worked quite a lot with robots in her job as an engineer — the kids had the French bulldog robot barking and wagging its tail in no time.

“I love this dog!” Karlie declared. “And the best part is we don’t even have to send it to obedience school. We can just program it.”

“Yeah, I just programmed him to eat my homework!” grinned Ty. The whole family laughed.

Editor’s note: Ty still had to do his homework.



Assembling the Pet Bed

Here's how to assemble the pet bed for your robotic pets!

1



With the pet bed die-cut cardboard on the table in front of you, fold the cardboard downward along all of the yellow lines and upward along all of the pink lines.

2

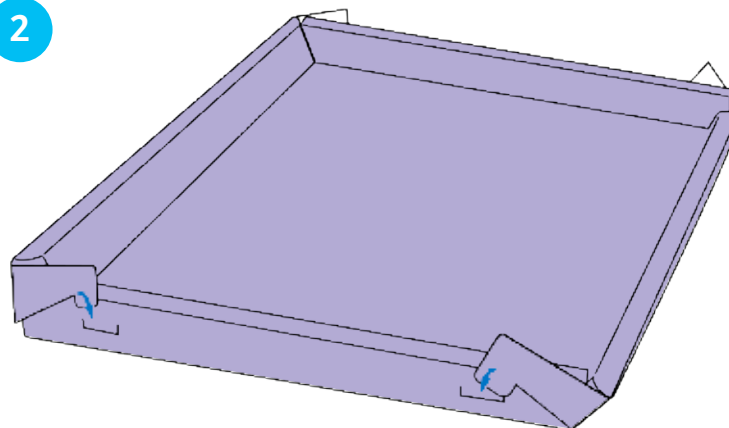

Clip the four side tabs into the slots (as indicated by the blue arrows in this diagram) to hold the bed together.

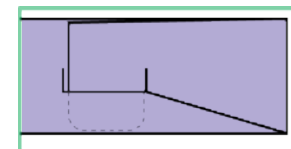

This is the side view of one of the tabs after it has been fully inserted into the slot.

1st Edition ©2020 Thames & Kosmos, LLC, Providence, RI, USA
Thames & Kosmos® is a registered trademark of Thames & Kosmos, LLC.

This work, including all its parts, is copyright protected. Any use outside the specific limits of the copyright law without the consent of the publisher is prohibited and punishable by law. This applies specifically to reproductions, translations, microfilming, and storage and processing in electronic systems and networks. We do not guarantee that all material in this work is free from copyright or other protection.

Technical product development: Genius Toy Taiwan Co., Ltd., Taichung, Taiwan, R.O.C.
Product development: Ted McGuire; Story: Dan Freitas and Ted McGuire; Manual layout: Mark Geary; Graphics and packaging: Dan Freitas
Illustrations: James Harmon

Manual assembly instruction diagrams: Genius Toy Taiwan Co., Ltd., Taichung, Taiwan, R.O.C., and Thames & Kosmos
Photos: Genius Toy Taiwan Co., Ltd., Taichung, Taiwan, R.O.C., and Thames & Kosmos

The publisher has made every effort to locate the holders of image rights for all of the photos used. If in any individual cases any holders of image rights have not been acknowledged, they are asked to provide evidence to the publisher of their image rights so that they may be paid an image fee in line with the industry standard.

Distributed in North America by Thames & Kosmos, LLC. Providence, RI 02903
Phone: 800-587-2872; Web: www.thamesandkosmos.com

Distributed in United Kingdom by Thames & Kosmos UK LP. Cranbrook, Kent TN17 3HE
Phone: 01580 713000; Web: www.thamesandkosmos.co.uk

We reserve the right to make technical changes.

Printed in Taiwan

